



McIntosh Laboratory, Inc. 2 Chambers Street Binghamton, New York 13903-2699 Phone: 607-723-3512 www.mcintoshlabs.com

# MX170

A/V Processor

Owner's Manual





The MX170 A/V Processor marries a long tradition of uncompromising quality with the latest home theater technologies to bring you an unsurpassed luxury entertainment experience.

The MX170's superior multichannel reproduction combined with RoomPerfect™ room correction technology provides the backbone of your cutting edge audio visual system.

---

### Safety First

---

Please read all the enclosed MX170 SAFETY INFORMATION included in separate documents. You can never be too safe.

---

### Thank you from all of us at McIntosh

---

You have invested in a precision instrument that will provide you with many years of enjoyment. Please take a few moments to familiarize yourself with the features and instructions to get the maximum performance from your equipment.

If you need further technical assistance, please contact your Dealer who may be more familiar with your particular setup including other brands. You can also contact McIntosh with additional questions or in the unlikely event of needing service.

#### McIntosh Laboratory, Inc.

2 Chambers Street

Binghamton, New York 13903

Technical Assistance: (607) 723-3512

Customer Service: (607) 723-3515

Fax:(607) 724-0549

Email: support@mcintoshlabs.com

Website: mcintoshlabs.com

---

### Make a Note

---

For future reference, you can jot down your serial number and purchase information here. We can identify your purchase from this information if the occasion should arise.

|                |  |
|----------------|--|
| Serial Number: |  |
| Purchase Date: |  |
| Dealer Name    |  |

## Table of Contents

|                                           |    |
|-------------------------------------------|----|
| Safety First.....                         | 2  |
| Thank you from all of us at McIntosh..... | 2  |
| Make a Note.....                          | 2  |
| Trademark and License Information.....    | 4  |
| What's in the box.....                    | 5  |
| Where to put it.....                      | 5  |
| Making the Cuts.....                      | 6  |
| Securing the MX170 to a Shelf.....        | 6  |
| Connections on the Back.....              | 7  |
| The Inputs.....                           | 7  |
| The Outputs.....                          | 7  |
| Making Connections.....                   | 8  |
| HDMI.....                                 | 8  |
| USB.....                                  | 8  |
| SD Card Slot.....                         | 8  |
| 10baseT LAN.....                          | 8  |
| Microphone.....                           | 8  |
| RS232.....                                | 8  |
| Wired IR Inputs.....                      | 8  |
| Digital Inputs.....                       | 9  |
| Analog Audio Inputs.....                  | 9  |
| Phono Input.....                          | 9  |
| AC Power.....                             | 9  |
| Power Switch.....                         | 9  |
| Balanced Audio Outputs.....               | 9  |
| Power Control (Trigger) Outputs.....      | 10 |
| Digital Zone B Output.....                | 10 |
| Net 2 Out.....                            | 10 |
| Data Out.....                             | 10 |
| The Front Panel.....                      | 11 |
| Standby / On.....                         | 11 |
| The Input Knob.....                       | 11 |
| The Volume Knob.....                      | 11 |
| The Arrow, Back and Select Buttons.....   | 11 |
| Trim Select Knob.....                     | 12 |
| Surround Mode Knob.....                   | 12 |

|                                             |    |
|---------------------------------------------|----|
| Zone B.....                                 | 13 |
| Display Mode.....                           | 13 |
| LED Channel Status Indicators.....          | 13 |
| Setup.....                                  | 13 |
| Setup- The Installer Menu.....              | 13 |
| Speaker Setup.....                          | 14 |
| Speaker Types for Setup.....                | 15 |
| Verify Speakers.....                        | 15 |
| Adjust Subwoofer Level.....                 | 15 |
| RoomPerfect™.....                           | 15 |
| Channel Gain.....                           | 15 |
| Audio Setup.....                            | 15 |
| Audio Processing.....                       | 15 |
| Voicing Setup.....                          | 16 |
| Zone B.....                                 | 16 |
| Source.....                                 | 16 |
| Video Setup.....                            | 17 |
| Video Output.....                           | 17 |
| Video Input.....                            | 17 |
| System Configuration.....                   | 17 |
| General Setup.....                          | 17 |
| Trigger Setup.....                          | 18 |
| Network Setup.....                          | 18 |
| Manage Software.....                        | 18 |
| Dolby-enabled speakers.....                 | 19 |
| Dolby Atmos and Auro-3D Setup Examples..... | 19 |
| Bass Management Examples.....               | 20 |
| Description of Remote Control Buttons.....  | 21 |
| Remote Control Batteries.....               | 22 |
| RoomPerfect™ Setup.....                     | 22 |
| Backup and Restore.....                     | 22 |
| Factory Reset.....                          | 23 |
| Update Software.....                        | 23 |
| Re-packing the MX170.....                   | 24 |
| Technical Specifications.....               | 25 |
| Voicing Curves.....                         | 26 |

## List of Figures



|                                                    |    |
|----------------------------------------------------|----|
| Figure 01– MX170 Dimensions.....                   | 5  |
| Figure 02– Custom cutout dimensions.....           | 6  |
| Figure 03– “L” bracket screws.....                 | 6  |
| Figure 04– MX170 Rear View.....                    | 7  |
| Figure 05– DB9 connector pin layout.....           | 8  |
| Figure 06– IR 3.5mm connector.....                 | 9  |
| Figure 07– Power control (trigger) mini plug.....  | 10 |
| Figure 08– Data Out mini plug.....                 | 10 |
| Figure 09– MX170 Front panel.....                  | 11 |
| Figure 10– Choosing SETUP from browser.....        | 14 |
| Figure 11– Speaker setup screen.....               | 14 |
| Figure 12– Auro-3D example: 11.1.....              | 19 |
| Figure 13– Dolby Atmos Example: 7.1.4.....         | 19 |
| Figure 14– 7.1.4 LFE Sub.....                      | 20 |
| Figure 15– 7.1.4 LFE Sub, Front XXL Speakers.....  | 20 |
| Figure 16– 7.1.4 Front Subs.....                   | 20 |
| Figure 17– 7.1.4 Front Speakers, XL Surrounds..... | 20 |
| Figure 18– RoomPerfect™ Focus Position.....        | 22 |





## Trademark and License Information

The McIntosh MX170 incorporates copyright protected technology that is protected by U.S. patents and other intellectual property rights. The MX170 uses the following technologies:

This item incorporates copy protection technology that is protected by U.S. patents and other intellectual property rights of Rovi Corporation. Reverse engineering and disassembly are prohibited.

| Trademark Logo                                                                      | License Information                                                                                                                                                                                                                                                                                                                                                                                                                                                                                                                                                                                                                                        |
|-------------------------------------------------------------------------------------|------------------------------------------------------------------------------------------------------------------------------------------------------------------------------------------------------------------------------------------------------------------------------------------------------------------------------------------------------------------------------------------------------------------------------------------------------------------------------------------------------------------------------------------------------------------------------------------------------------------------------------------------------------|
|     | Manufactured under license from Auro Technologies. Auro-3D® and the related symbols are registered trademarks of Auro Technologies. All materials contained in this work are protected by copyright law and may not be reproduced, distributed, transmitted, displayed, published or broadcast without the prior written permission of Auro Technologies NV or in case of third party materials, the owner of that content. You may not alter or remove any trademark, copyright or other notice from copies of the content. Auro Technologies: mail info@auro-technologies.com, phone +32-(0)-14314343, fax +32-(0)-14321224, www. auro-technologies.com. |
|   | Manufactured under license from Dolby Laboratories. Dolby, Dolby Atmos, Dolby Surround, and the double-D symbol are trademarks of Dolby Laboratories.                                                                                                                                                                                                                                                                                                                                                                                                                                                                                                      |
|  | For DTS patents, see <a href="http://patents.dts.com">http://patents.dts.com</a> . Manufactured under license from DTS, Inc. DTS, the Symbol, DTS in combination with the Symbol, DTS:X, and the DTS:X logo are registered trademarks or trademarks of DTS, Inc. in the United States and/or other countries. © DTS, Inc. All Rights Reserved.                                                                                                                                                                                                                                                                                                             |

| Trademark Logo                                                                      | License Information                                                                                                                                                                     |
|-------------------------------------------------------------------------------------|-----------------------------------------------------------------------------------------------------------------------------------------------------------------------------------------|
|  | HDMI, the HDMI Logo and High-Definition Multimedia Interface are trademarks or registered trademarks of HDMI Licensing LLC in the United States and other countries.                    |
|  | Manufactured under license from Lyngdorf Audio A/S. RoomPerfect™ is a registered trademark and the RoomPerfect™ logo is a trademark of Lyngdorf Audio A/S. (C) Lyngdorf Audio A/S 2009. |

## What's in the box

Here is what is in the box besides all the shipping foam:

One MX170 A/V Processor

One accessory package including

- Microphone
- Microphone stand
- Microphone clip
- 25-foot XLR microphone cable

One hardware package

- Two "L" Mounting brackets (for securing unit to shelf)
- Two screws #6 x 1/2 inch
- Four #6 washers

One manual package including this manual

One AC power cord

## Where to put it

The MX170 A/V Processor can be placed upright on a table or shelf, standing on its four feet. It also can be custom installed in a piece of furniture or cabinet. The four feet may be removed for custom installations. If the feet are removed, the four feet together with the mounting screws should be retained for possible future use. **Do not use different size screws** when re-installing the feet. With the feet removed, the MX170 requires a ventilation cutout. Dimensions for the panel cutout and bottom ventilation cutout are shown in Figure 02 on page 6.

Always provide adequate ventilation for your MX170. Cool operation ensures the longest possible operating life for any electronic instrument. Do not install the MX170 directly above a heat generating component such as a high-powered amplifier. If all the components are installed in a single cabinet, a quiet running ventilation fan can be a definite asset in

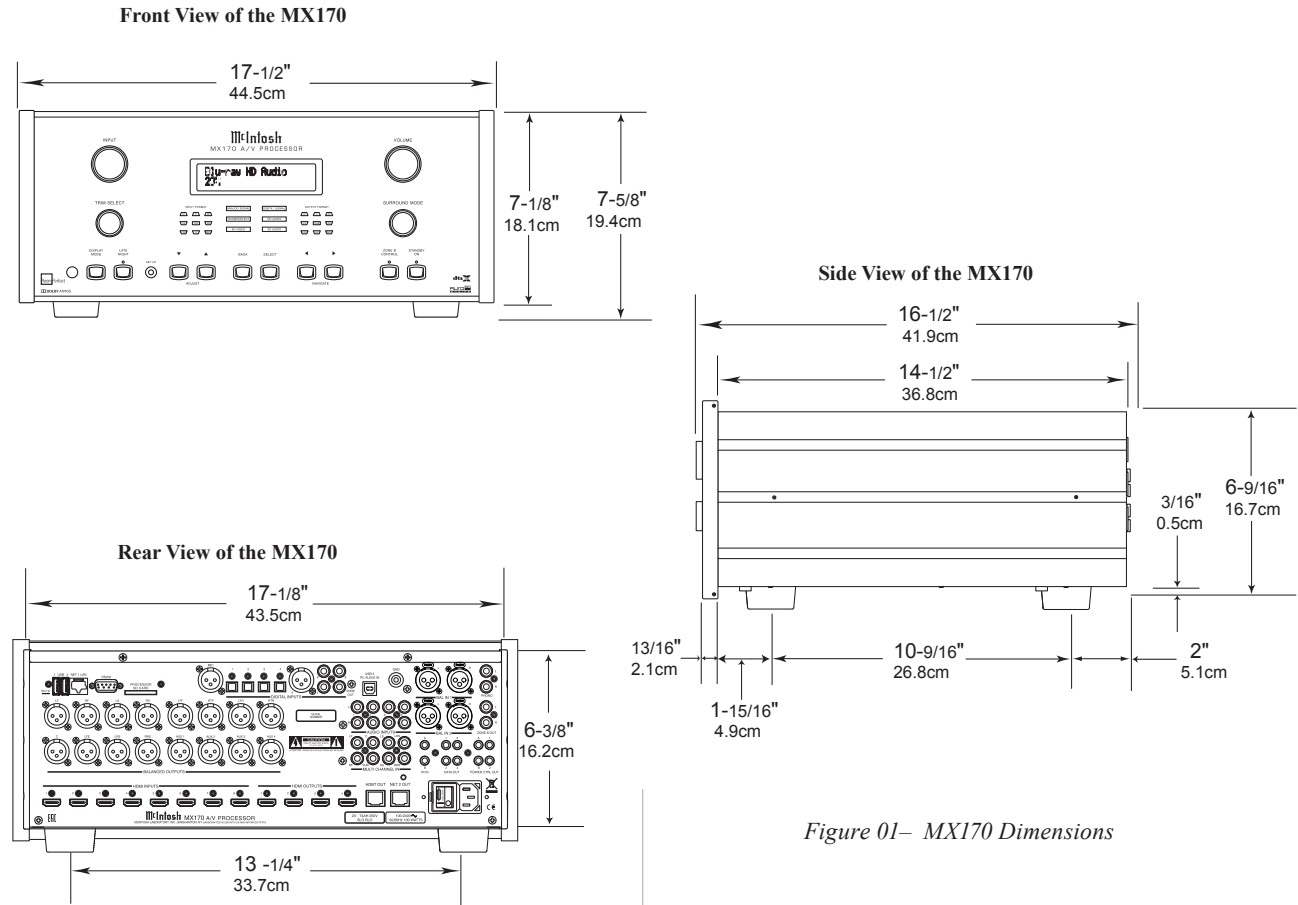

Figure 01- MX170 Dimensions

maintaining all the system components at the coolest possible operating temperature.

A custom cabinet installation should provide the following minimum spacing dimensions for cool operation:

- 2 inches (5.1cm) above the top
- 2 inches (5.1cm) below the bottom
- 1 inch (2.5cm) on each side of the MX170 so that airflow is not obstructed

- 20 inches (50.8cm) depth behind the front panel
- 1-7/16 inch (3.7cm) in front of the mounting panel for knob clearance

Be sure to cut out a ventilation hole in the mounting shelf according to the dimensions in the drawing. Figure 02 on page 6.



## Making the Cuts

Here are the dimensions for the cutouts needed for custom installation. A ventilation opening is essential for any installation with the four feet removed.

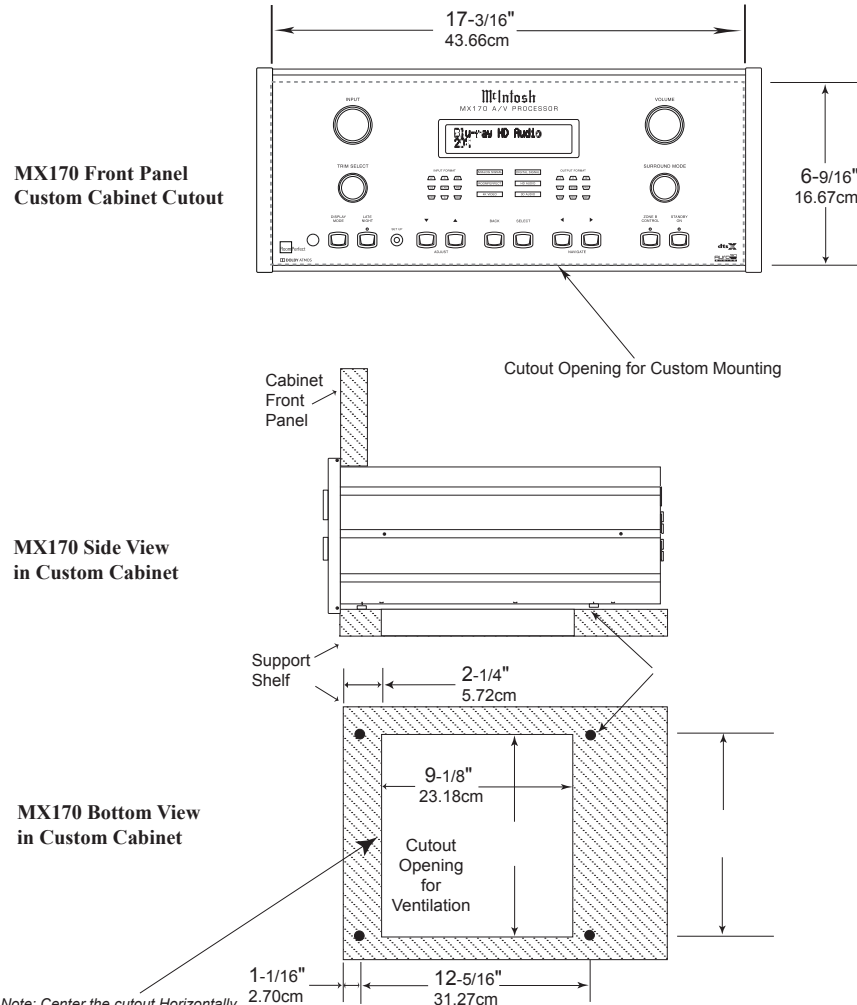

Figure 02– Custom cutout dimensions

## Securing the MX170 to a Shelf

A hardware package containing two “L” brackets and two screws along with four washers can be used to secure the MX170 A/V Processor to a shelf.

To secure the MX170 to a shelf using the supplied “L” brackets:

- Remove the two screws in the lower corner on the back of the MX170. See Figure 03.
- Attach the longer portion of the “L” bracket to the rear of the MX170 using the same screw just removed from the rear of the MX170 and a supplied washer. Repeat for the other side. Never use different size screws. The “L” bracket should form a 90 degree angle with the lower portion facing away from the rear of the unit and resting on the shelf.
- Use the supplied screws and washers to attach the lower portion of the “L” brackets to the shelf.

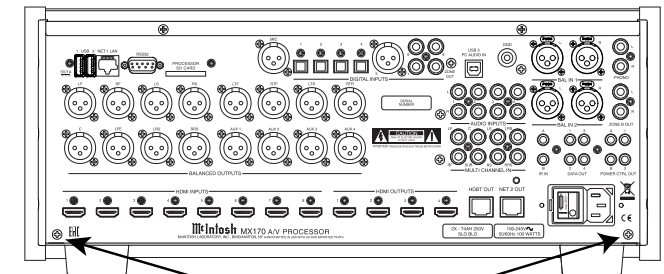

Screws for attaching “L” brackets

Figure 03– “L” bracket screws

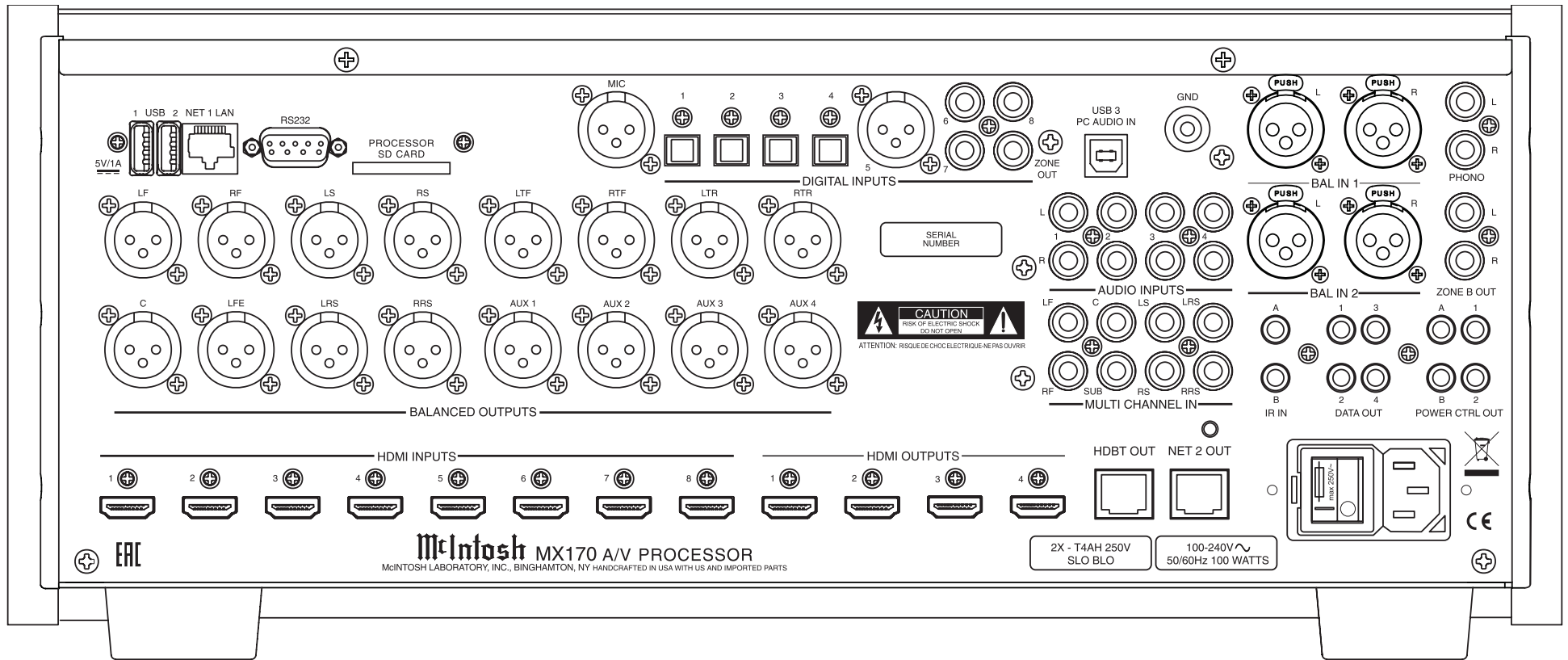

Figure 04– MX170 Rear View

## Connections on the Back

The MX170 A/V Processor has a wealth of connections. They can be divided into Inputs and Outputs.

### The Inputs

- Eight HDMI Inputs
- Four optical Inputs
- One balanced XLR (AES/EBU)
- Three coaxial digital audio Inputs
- Four analog RCA stereo pairs
- Two analog XLR stereo pairs

- One 8 multichannel RCA Inputs
- One Moving Magnet RCA stereo pair
- Two USB file/update Inputs
- One USB streaming audio Input
- One SD card slot (Stores Backup data)
- One 10baseT LAN connector
- One microphone Input for RoomPerfect™ setup
- One RS232 connector
- Two wired IR Inputs (one wireless IR on front)
- One AC connector

### The Outputs

- 16 balanced audio Outputs
- One coaxial digital audio Output (for Zone B)
- One Zone B RCA stereo pair
- One HDbaseT Output
- Four Power Control (trigger) Outputs
- One Net 2 Out
- Four Data Out



## Making Connections

### HDMI

The MX170 A/V Processor has 8 HDMI Inputs. A high-performance HDMI cable is recommended to take advantage of the 18 Gbps speed capabilities of all 8 HDMI Inputs. The HDMI cables should support 4K@60Hz, HDR and YCbCr 4:2:2 (4:4:4/RGB) as well as Ethernet and ARC. Cables designed for HDMI 2.0 are fine. Though, HDMI is backward compatible, older cables may have issues with the higher bandwidth required for newer protocols.

When connecting to ARC enabled televisions, Audio Return Channel (ARC) can provide two-way communication between units allowing for power control, volume control and lip-syncing functions to ensure audio and video are perfectly matched. This allows for more intelligent operation between components as well as less cable clutter. Make sure this feature is enabled in your TV's setup menu. HDMI Output 1 supports eARC. eARC allows for even higher bandwidth and will allow for higher quality audio including uncompressed 7.1 surround, Dolby Atmos and DTS:X.

Though this manual divides HDMI jacks between Inputs and Outputs, it should be noted that HDMI communication is bidirectional. HDMI devices perform a handshake to negotiate capabilities. When connecting an eARC high-speed device, HDMI Output 1 should be used for the connection. HDMI Output 1 will receive information from the connected device as well as transmit high-speed data.

### USB

There are three USB Inputs. The two USB Type-A Inputs are labeled USB 1 and 2. These two Inputs are for data transfer and updating the MX170. Voicings can be backed up and restored using either of these ports.

The USB Type-B Input labeled USB 3 PC AUDIO IN is used for USB audio connections from sources such as a computer.

Do not use the USB ports for charging smartphones and tablets.

### SD Card Slot

Like the USB Inputs, the SD Card Slot can be used for data transfer and back up and restore functions of the MX170.

### 10baseT LAN

Use an ethernet cable to connect the MX170 to a network router. This will allow setup and control of the unit to be performed through a browser. Setup is easier to navigate using a computer. To see the IP address of a network connected MX170, push the DISPLAY MODE button on the front of the unit until the address is displayed. Putting this address into a locally connected browser will allow control of the unit remotely.

### Microphone

Use the microphone Input for connecting the supplied MX170 Microphone with the included microphone (XLR) cable. This is used for the RoomPerfect™ calibration for tuning the system to your room. For instructions see “RoomPerfect™ Setup” on page 22.

### RS232

The RS232 connection can be used for integration into a home automation system.

The RS232 Input will accept a male DB9 connector. Most installations require a null modem cable. The port settings should be:

- 8 data bits, no parity and one stop bit
- Baud rate fixed at 115,200 bits per second

For further information on using the RS232 control protocol or using RS232 over IP or HDMI, you should request the document “MX170 A/V Processor Serial Control Manual” from your dealer or McIntosh Technical Assistance (see page 2).

RS232 DB9 Connector Pin Layout:

- |                        |        |
|------------------------|--------|
| 1. N/C (no connection) | 6. N/C |
| 2. Data In (RXD)       | 7. N/C |
| 3. Data Out (TXD)      | 8. N/C |
| 4. N/C                 | 9. N/C |
| 5. Gnd.                |        |

See “Figure 05– DB9 connector pin layout”.

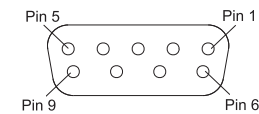

Figure 05– DB9 connector pin layout

### Wired IR Inputs

The IR Inputs allow two IR receivers to be attached to the MX170. The Inputs are labeled “A” and “B” and each can control their respective zones. By attaching an IR receiver using a 3.5mm cable (see “Figure 06– IR 3.5mm connector”), a Remote Control can be used in another location without a line-of-sight to the MX170's front IR sensor. In this



way, if Zone B is in another room, a Remote Control can be used to adjust the MX170.

If using an external IR receiver for Zone A in the same room as the MX170, you may wish to disable the front IR sensor, which also controls Zone A, to avoid timing issues of receiving the remotes commands from two Inputs. The front IR can be turned on/off in the Setup Menu:

SETUP>System configuration>General setup  
(For explanation of menu path notation see the box on page 14.)

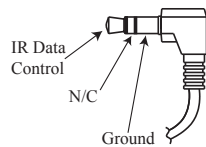

Figure 06– IR 3.5mm connector

## Digital Inputs

There are 8 digital Inputs in the MX170

- 4 Optical
- 1 Balanced XLR (AES/EBU)
- 3 Coaxial

These Inputs are labeled 1 through 8 on the rear of the MX170. A Digital Optical Audio Cable Toslink Cable would be used for Inputs 1 through 4. Input 5 accepts a Balanced XLR (AES/EBU) cable and Inputs 6 through 8 accept Digital Audio Coaxial Cable which use a male RCA type connector.

These Inputs are named SPDIF 1 through 8. All names can be customized in the setup program. Unused Inputs can be deleted (and later restored).

## Analog Audio Inputs

The MX170 can accept Input from seven analog audio sources:

- There are four pairs of RCA jacks numbered 1 through 4 above the AUDIO Inputs title on the

rear of the MX170. The left male RCA jack of a stereo pair should plug into the top jack and the right male RCA jack should plug in below it. In the SETUP menu and Input selection, these Inputs are called “Analog 1 through 4.”

- There are two pairs of XLR balanced connections labeled “BAL IN 1” and “BAL IN 2”. The left and right pairs are next to each other and will accept male XLR cables. Looking at the back, left is on the left and labeled “L”, the other is labeled “R”.
- The eight RCA jacks above the title “MULTI CHANNEL IN” accept eight channel audio and are called “8 Channel Analog” in the Input menu. The channels are:
  - LF (Left Front)
  - C (Center)
  - RF (Right Front)
  - LS (Left Surround)
  - RS (Right Surround)
  - LRS (Left Rear Surround)
  - RRS (Right Rear Surround)
  - LFE (Low Frequency Effects)

All the Input names can be customized in the SETUP program, as well as deleted and restored.

## Phono Input

A gold-plated stereo pair of RCA jacks and a gold-plated ground post are for connecting a turntable with a moving magnet cartridge to the precision phono preamp section of the MX170. Turning the ground post counterclockwise will loosen the post and reveal a hole in the post for inserting the ground wire. Turn clockwise to secure the ground wire.

## AC Power

This connection is essential. Plug the female end of the supplied AC Power Cord into the AC connector located in the rear right corner of the MX170. Plug the male end of the AC Power Cord into a grounded and functioning AC outlet.

## Power Switch

The Power Switch controls the overall power to the MX170. With the switch in the “0” position, the standby button, or the Remote Control power button will not turn the unit on. With the Power Switch in the “I” position, the MX170 is in standby mode and can be powered on and off via the front standby switch and Remote Control.

## Balanced Audio Outputs

There are 16 male balanced XLR connections on the back of the MX170 to accommodate a wide variety of speaker configurations. Connect balanced XLR cables to the corresponding powered speakers or amplifiers. Here are the possible connections:

- LF (Left Front)
- RF (Right Front)
- LS (Left Surround)
- RS (Right Surround)
- LTF (Left Top Front)
- RTF (Right Top Front)
- LTR (Left Top Rear)
- RTR (Right Top Rear)
- C (Center)
- LFE (Low Frequency Effects)
- LRS (Left Rear Surround)
- RRS (Right Rear Surround)
- AUX1

- AUX2
- AUX3
- AUX4

This is all easier said than done. Setting up speakers for a surround system takes planning, measuring and installation. Depending on your level of expertise and available time, you may wish to employ the services of your McIntosh Dealer for expert setup of your system. Professional installation of in-ceiling speakers is particularly important due to gravity and the location above your head.

The number, types and locations of speakers are key elements in setting up the system. There are a multitude of possible configurations, and the MX170 is very flexible in its setup to adapt to many configurations.

Often surround setups are referred to by numbers for example 7.1.4 or 9.1.2. The first number refers to the number of traditional surround speakers (front, center and surround). The second number is the number of subwoofers that can be connected, and the third number refers to the number of in-ceiling or upward firing speakers in the setup.

The type of speaker (size and location) will be entered later during Speaker setup. The distance of the speaker from the listening location will be entered in the RoomPerfect™ setup. Make note of this information.

At this stage, the connection from the MX170 to the various amplifiers and powered speakers should be made using quality balanced XLR cables.

## Power Control (Trigger) Outputs

The MX170 has four power control Outputs, one for Zone A and one for Zone B, and two that allow for custom setup. Power Control enables power on/off signals to go to connected components so that other

components can automatically power on (or off) as called for by the MX170. For example, you may want a DVD player and certain monitor to power on when HDMI 1 Input is selected, or you may want all components to power off when powering off the MX170.

Connect components using a 3.5mm stereo mini plug. See Figure 07 below.

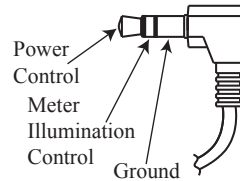

Figure 07– Power control (trigger) mini plug

For components that will power on when Zone A is active, use Power “A” and for Zone B use Power “B”. For custom settings, connect to Power “1” and Power “2” which will be configured in the Setup program later on.

## Digital Zone B Output

This coaxial digital audio Output provides a fixed level Output from the selected Zone B source. Use a digital coaxial cable with a male RCA connector.

## Net 2 Out

This port allows an additional network connected component to be connected without needing an additional router port. Use an ethernet cable to connect the component to the Net 2 Out port. This port functions when the MX170 is on or in “Network” Standby mode. In “Deep sleep” standby mode, the Net 2 Port will not function. Standby options are controlled in SETUP>System configuration>General setup> under the Power management section. (For explanation of menu path

notation see the box on page 14.)

## Data Out

The MX170 will convert IR Remote Control data to share with McIntosh components connected to the Data Ports. This allows units out of range of an IR signal to receive commands. There are four Data Ports. Each port can be assigned to different Inputs so that only the components involved with the Input will receive data. For instance, HDMI 1 can be assigned to DATA OUT 1 and a connected McIntosh DVD player can be controlled when the HDMI Input is selected. A unit connected to a different Data Port would not receive the commands.

To assign a Data Port to an Input, go to SETUP>Source>[choose source]>Data out>[select data out #].

To connect a McIntosh unit to a Data Port, use a 3.5mm stereo mini phone plug cable. See Figure 08.

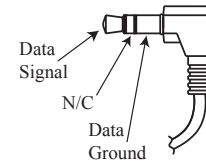

Figure 08– Data Out mini plug

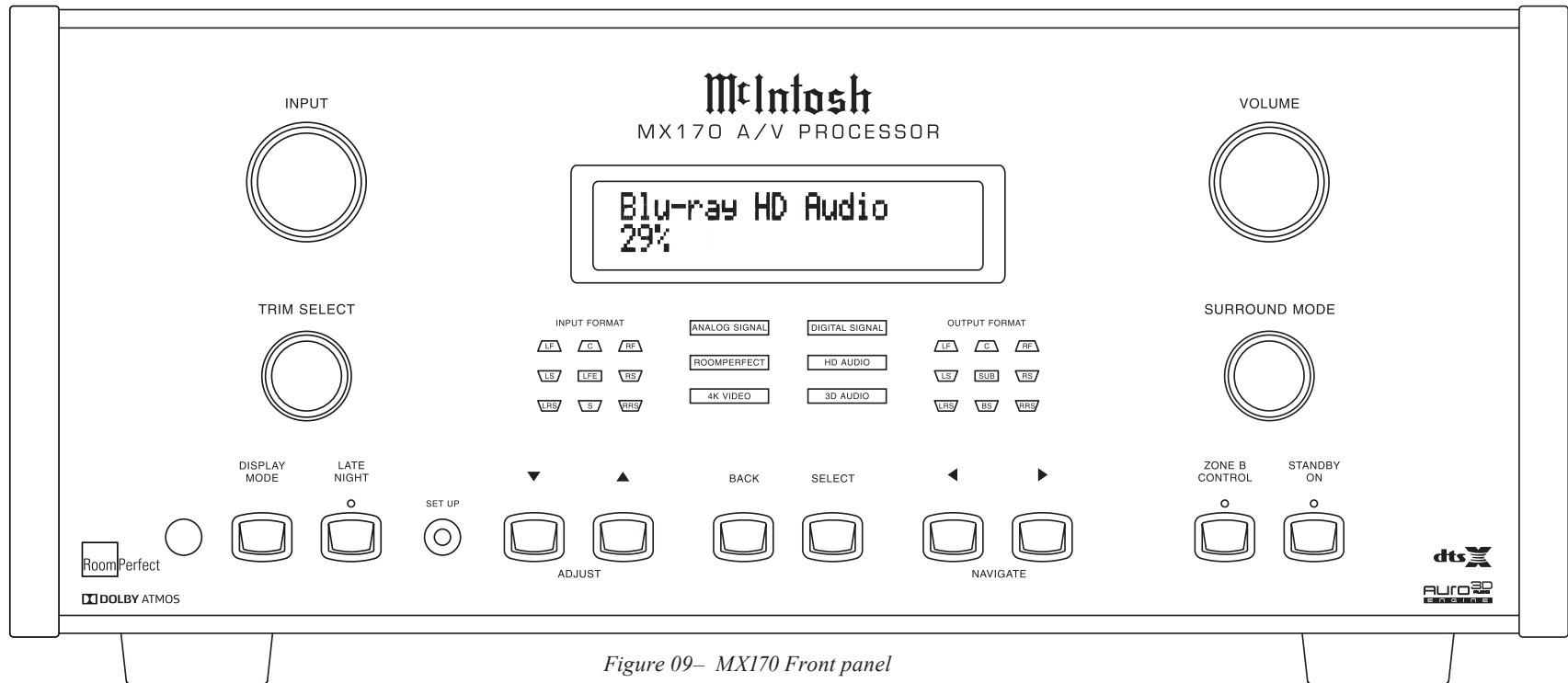

Figure 09– MX170 Front panel

## The Front Panel

The iconic front glass panel of the MX170 provides knobs and buttons to control the unit as well as an informational display and LED status lights that display the current mode.

### Standby / On

The red STANDBY / ON button toggles the MX170 between on and standby mode. The STANDBY button will only work if the rear Power Switch (page 9) is on. When the unit is in standby mode, it can also be toggled on/off using the Remote Control or the browser interface. To use the on/off button in the top right corner of the browser interface, the MX170's power management must be set to "Network" as opposed to "Deep sleep."

When the power management is set to Deep Sleep, the MX170 can not be woken up from the network interface. The Power management can be setup under SETUP>System configuration>General setup>Power management. (For explanation of menu path notation see the box on page 14.)

### The Input Knob

The Input Knob can be turned clockwise or counterclockwise to scroll through all the Inputs that are enabled in Setup. All Inputs are available by default.

## The Volume Knob

Turn this knob clockwise to raise the volume and go the other way to make it quieter. A maximum volume of 59% is the factory default, but this can be set to any value between 12% and 99% in Setup. A maximum volume prevents the MX170 from accidentally sending higher signals than your situation permits. See "General Setup" on page 17.

## The Arrow, Back and Select Buttons

These buttons are used to navigate menu screens and selections in the Trim menus. The arrows allow scrolling up ▲, down ▼, left ◀, and right ▶, when those are menu choices. The SELECT button accepts an option and the BACK button returns to



the previous menu.

## Trim Select Knob

Now that you are familiar with the arrow, Back and Select buttons, you can change many settings using the Trim Select Knob. Turn the Trim Knob to access any of the following:

- **Voicing-** There are seven built-in equalization settings. Use the up ▲ and down ▼ buttons to scroll through the choices. You can push SELECT to choose and return to the previous screen or wait a few seconds and this will happen automatically. The built-in equalization settings are: Neutral (flat), Music, Music II, Relaxed, Tilt, Action, and Action+Movie. You can edit existing voicings and add new ones in SETUP. Go to SETUP>Audio setup>Voicing setup and choose a voicing to edit or choose “Add” and create a new voicing with up to eight filters.
- **Bass-** Use the up ▲ and down ▼ buttons to adjust the bass level between -12dB and +12dB in 0.5dB increments. The right ► and left ◀ buttons set the upper adjustment limit between 20Hz and 800Hz in 10Hz increments. The adjustment is saved for an individual Input.
- **Treble-** Use the up/down ▲▼ buttons to adjust the treble level between -12dB and +12dB in 0.5dB increments. The right/left ►◀ buttons set the lower adjustment limit between 1,500Hz and 16,000Hz in 500Hz increments. The adjustment is saved for an individual Input.
- **VFD Level-** Use the up/down ▲▼ buttons to set the brightness level of the VFD (Vacuum Fluorescent Display). The default for the information display is 100% which can be changed to 25%, 50% or 75%.

- **Lip Sync-** This trim adjustment allows the timing of the audio to be adjusted for synchronization to video. Use the up/down ▲▼ arrows for 5ms increments and the right/left ►◀ buttons for 25ms increments up to a total of 500ms.
- **AMP Light-** This allows for the meter lights, of a McIntosh amplifier connected with a power control cable, to be toggled on and off using the up ▲ and down ▼ buttons.
- **Trim Center-** This trim adjustment allows for the adjustment of the Center Channel volume level relative to the Front and Surround Channels. Use the up/down ▲▼ buttons to adjust from -10dB to + 10dB in 1dB increments.
- **Trim Center-** This trim adjustment allows for the adjustment of the Center Channel volume level relative to the Front and Surround Channels. Use the up/down ▲▼ buttons to adjust from -10dB to + 10dB in 1dB increments. Any adjustment will be lost when the Input is changed.
- **Trim Surrounds-** This trim adjustment allows for the adjustment of the Surround Channels volume level relative to the Front, Center and LFE Channels. Use the up/down ▲▼ buttons to adjust from -10dB to + 10dB in 1dB increments.
- **RoomPerfect™** - The RoomPerfect™ room correction process (“RoomPerfect™ Setup” on page 22) can generate correction settings for up to four Focus positions as well as a more general Global setting. This trim setting allows quick access to change between various saved settings or to Bypass RoomPerfect™ altogether. Use the up/down ▲▼ buttons to scroll through all saved settings.

## Surround Mode Knob

The MX170 provides eleven different default Surround Modes. These modes include upmixing options such as DTS NEO X which will create up to 11.1 channel surround from sources like 5.1 and 7.1 surround signals or even from stereo signals. Dolby restricts the upmixing of Dolby signals to Dolby upmixer. Non-Dolby upmixer choices will have no effect on a Dolby source. Therefore, Dolby upmixer should be selected for all Dolby upmixing, and will work on non-Dolby signals as well. The MX170 Surround Processing Modes are:

- None
- Dolby Upmixer
- Neural:X
- Auro-3D/Auromatic
- Auro-2D
- Auro-Stereo
- Auro-Native (as recorded)
- Virtual-X
- Legacy (see below)
- Stereo (This will downmix the signal)
- Party

The Legacy Mode will pass older non-Auro, non-DTS:X, non-Atmos formats with no height or object oriented content without upmixing. This content may include Dolby TrueHD, Dolby Digital, Multichannel PCM, DTS Master Audio, as well as stereo and surround formats up to 7.1.

Below are speaker configurations for Auro-3D and Dolby Atmos. If Dolby Atmos material is played in an Auro-3D setup, the system will try to match the Auro-3D specific speakers to the nearest Dolby Atmos equivalent; the same goes for playing Auro-3D material on a Dolby Atmos setup. The system will also handle hybrid setups with both types of

speakers.

Auro-3D:

- HL (Height Left)
- HC (Height Center)
- HR (Height Right)
- HLS (Height Left Surround)
- HRS (Height Right Surround)
- TOP (Top ceiling, AKA VoG / Voice of God)

Dolby Atmos:

- LTF (Left Top Front)
- RTF (Right Top Front)
- LTM (Left Top Middle)
- RTM (Right Top Middle)
- LTR (Left Top Rear)
- RTR (Right Top Rear)
- LW (Left Wide)
- RW (Right Wide)

For examples, see “Dolby Atmos and Auro-3D Setup Examples” on page 19.

DTS:X boasts the flexibility to support any standard surround setup as well as configurations up to an 11.2 channel system.

## Zone B

The ZONE B CONTROL button allows the front panel to be used to control the power, Input and volume for components connected to the Zone B Output of the MX170. Zone B can be set to any Input or can be set to follow whatever Input is chosen for the Main Zone. In the Zone B mode, the red LED above the ZONE B button will illuminate. If Zone B is off, turn it on by pushing the STANDBY ON button which will also have a red light lit above it. To exit Zone B control, push the Zone B button again.

If ZONE A is powered off while Zone B is still on, re-powering Zone A will automatically mute Zone B.

## Display Mode

The front panel will show the current Input, voicing setting and volume level by default. Using the DISPLAY MODE button, additional information can be accessed. Pushing the DISPLAY MODE button will toggle through the following additional screens:

1. Format of incoming audio signal
2. Processing status of the Audio Out signal
3. Incoming and outgoing resolution of the current video signal
4. The current IP address of the MX170

The default screen will return after a few seconds.

## LED Channel Status Indicators

The yellow LEDs in the center of the MX170 front panel provide a visual display of the status of the Main Zone’s signal.

The left side illuminates which channels are present in the Input format of the signal.

The middle section shows the following information:

- ANALOG SIGNAL
- DIGITAL SIGNAL
- RoomPerfect™
- HD AUDIO
- 4K VIDEO
- 3D AUDIO

The right side shows the channels of the audio Output.

Here are the channel abbreviations used on both the left side (Input FORMAT) and right side (Output FORMAT) indicators:

- LF- Left Front
- C- Center
- RF- Right Front
- LS- Left Surround
- LFE- Low Frequency Effects
- SUB- Subwoofer
- RS- Right Surround
- LRS- Left Rear Surround
- S- Surround (RS + LS)
- BS- Back Surround (RS + LS)
- RRS- Right Rear Surround

## Setup

Pushing the SETUP button will bring up the Installer menu on an attached monitor. When in setup mode the Display will read “Installer Menu”. To exit setup mode, push the SETUP button again.

## Setup- The Installer Menu

The factory default settings will allow you to use the MX170 as soon as you properly connect your components. But the setup program is quite robust and allows for great customization and optimization.

MX170 setup can be performed by using either the setup button on the front panel and using an attached monitor or through a web browser on a computer if the MX170 is connected to your network. Chrome or Firefox browsers are recommended. Other browsers may not function correctly.

The procedures and screens are essentially the same using either method. You may find the use of a mouse and a keyboard available in the browser method easier to navigate than using the arrow ▲▼◀▶ buttons on the front panel or Remote Control for entering information.

We will be using the browser setup method here, but



the underlying logic and procedures are the same.

To bring up the interface on your browser, put the IP address of the MX170 in the address bar. To determine the IP address, push the DISPLAY MODE button until the IP address appears in the display.

Choose SETUP from the top left of the screen. The local version will start in the SETUP menu. (See Figure 10.)

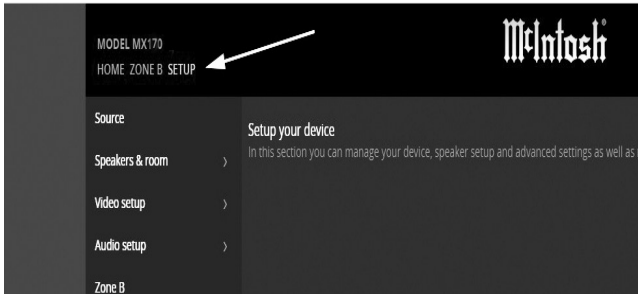

Figure 10– Choosing SETUP from browser

Setup has the following sub-menus:

- Source
- Speakers & room
- Video setup
- Audio setup
- Zone B
- System configuration
- Manage software

**In this manual, sub menus are denoted in the style “SETUP>Video setup>Video Input” which means from the “SETUP” menu choose “Video setup” and then choose “Video Input”.**

## Speaker Setup

### SETUP>Speakers & room>Speaker setup

This is where to tell the MX170 the numbers and

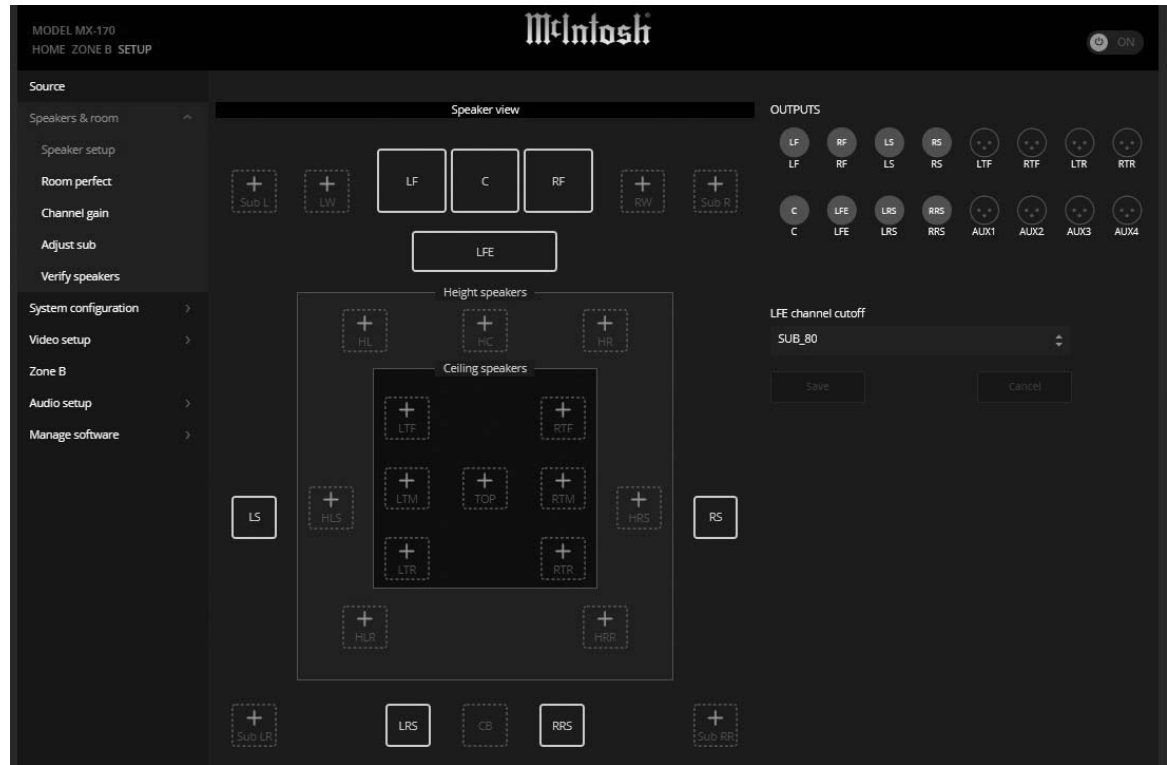

Figure 11– Speaker setup screen

types of speakers in your system. When entering this menu, you will need to acknowledge that “any changes to the speaker setup will require rerunning your RoomPerfect™ measurements.” Choose “Proceed” to continue.

Select a speaker location starting with the LF (or RF- they will be the same). Choose the speaker size according to this guide:

Speaker size:

- NONE- This means the Output is not used
- XXL- Plays a full range signal and can accept bass re-directed from other channels when in the LF/RF, LS/RS and LRS/RRS positions
- XL- Full range but bass will not be re-directed to these speakers

- L- Bass cutoff frequency is 40Hz
- M- Bass cutoff frequency is 80Hz
- S- Bass cutoff frequency is 100Hz
- XS- Bass cutoff frequency is 120Hz
- Custom- Bass cutoff can be manually set

When choosing a custom cutoff frequency, select a frequency higher than the lowest frequency that your speaker can play. If redirected bass will be played by a subwoofer instead of the full range speaker, choose a cutoff lower than the highest frequency the subwoofer can play.

The Bass cutoff frequency option is only available for the Custom speaker choice. Choose a bass cutoff frequency for custom speaker setting.

Enabling Natural roll-off (choosing “Yes”) will send the full range signal to the speaker as well as sending the bass frequency based on the cutoff to a subwoofer or XXL speaker.

Enabling bi-amping (choosing “Yes”) will send an exact copy of the existing signal to a pair of AUX Outputs. This option is only available for the LF/RF speakers.

Add each speaker you have by selecting the + by appropriate description and filling in the data. The speaker will be assigned to an Output.

## Speaker Types for Setup

| Position | Description                     |
|----------|---------------------------------|
| L        | Left                            |
| C        | Center                          |
| R        | Right                           |
| Sub L    | Subwoofer Left                  |
| LW       | Left Wide                       |
| RW       | Right Wide                      |
| SUB R    | Subwoofer Right                 |
| SUB LFE  | Subwoofer Low Frequency Effects |
| HL       | Height Left                     |
| HC       | Height Center                   |
| HR       | Height Right                    |
| LTF      | Left Top Front                  |
| RTF      | Right Top Front                 |
| HLS      | Height Left Surround            |
| LTM      | Left Top Middle                 |
| TOP      | Top Ceiling/Voice of God        |
| RTM      | Right Top Middle                |

| Position | Description           |
|----------|-----------------------|
| HRS      | Height Right Surround |
| LS       | Left Surround         |
| LTR      | Left Top Rear         |
| RTR      | Right Top Rear        |
| HLR      | Height Left Rear      |
| HRR      | Height Right Rear     |
| SUB LR   | Subwoofer Left Rear   |
| LRS      | Left Rear Surround    |
| CB       | Center Back           |
| RRS      | Right Rear Surround   |
| SUB RR   | Subwoofer Right Rear  |

## Verify Speakers

### SETUP>Speakers & room>Verify speakers

Select “Verify speakers” to step through each connected speaker. Sound should be heard from the current speaker. Select “Next” or “Previous” to cycle through available speakers.

## Adjust Subwoofer Level

### SETUP>Speakers & room>Adjust Sub

The Adjust Sub menu is a tool for setting the level for an attached subwoofer. It will compare the level of the Front Left speaker and the subwoofer. It will then suggest changes to make on the level adjustment for a powered sub.

To use this tool, attach the included microphone and cable to the MIC jack in the rear of the MX170 and position the microphone in the primary listening location. Select start and follow the prompts.

It is advisable to perform the sub adjustments prior to using RoomPerfect™. RoomPerfect™ will perform fine tuning of your system, but it is better to

manually set your preferred overall subwoofer level as opposed to using equalization to accomplish this.

## RoomPerfect™

RoomPerfect™ is an advanced calibration and adjustment system that will get the most out of your system. For setup instruction see “RoomPerfect™ Setup” on page 22.

## Channel Gain

### SETUP>Speakers & room>Channel gain

Channel gain allows for full range (20Hz-20kHz) adjustments of gain by channel. Changes can be made for each saved RoomPerfect™ setting including Global and Bypass.

- Choose “Edit” to make changes
- Choose the RoomPerfect™ settings you wish to adjust
- Settings can be changed for Dolby Atmos/DTS and for Auro signals
- Choose “Save” to keep the new settings or cancel to lose your changes

If you wish to make gain adjustments that are not full range (so as to not effect a sub playing that channel for instance), use Speaker Setup (page 14) instead.

## Audio Setup

The Audio setup menu consists of two sub menus: Audio Processing and Voicing setup.

## Audio Processing

### SETUP>Audio setup>Audio processing

This menu allows for management of the audio processing presets for DTS, AURO and Dolby.



**For DTS**, center gain adjustments can be set for the three available DTS presets (Neo:X music, Neo:X game and Neo:X cinema). Dynamic range control, also known as Night Mode, can be enabled and percentage of control set. Night Mode raises the volume of quiet sounds and lowers the volume of loud sounds. Enabling Phantom Center allows a center channel to be generated from left and right stereo signals. Enabling channel remapping will allow for remixing of the soundtrack to compensate for a different channel layout from the original mix. Enabling Fade In will allow the volume to come up to level gradually when the Input is chosen.

**For Dolby**, enabling Center Spread will spread the center channel dialogue into the left and right speakers to accommodate very large screens. There are two different Dolby dynamic range controls (Night Modes), one for TrueHD and one for Atmos. Each can be enabled separately for program material of that type. Auto for TrueHD will follow the instructions of the TrueHD source.

**For AURO**, the “Set AURO strength” changes the level of upmixed channels relative to the original Input signal. AURO presets have settings optimized for different audio material:

|         |                                                                    |
|---------|--------------------------------------------------------------------|
| small   | pop/chamber music and movies with a lot of dialog such as comedies |
| medium1 | jazz and typical movies and TV shows                               |
| medium2 | orchestral/ larger spaces and action movies with big explosions    |
| speech  | Primarily dialog with little spatial information such as news      |

## Voicing Setup

### SETUP>Audio setup>Voicing setup

A Voicing is an equalizer filter that can be activated

to amplify or attenuate certain frequencies according to your personal preferences. This equalization is an addition to the RoomPerfect™ corrections. Voicing setup allows you to edit, delete, add, or load voicings.

In the web interface (recommended), you can edit or add a voicing by combining up to eight filter sections. For each section, you can choose between parametric or high and low shelves as well as high and low-pass filters. Once the filter type is selected, you can insert a center frequency, Q (bandwidth), and gain. Then the filter, including the final voicing, is shown as a graph so that you can immediately see the result.

Voicing can be accessed through the Trim Select Knob (page 12).

## Zone B

### SETUP>Zone B

Use this menu to set default values for Zone B. A maximum volume can be set. A fixed volume can also be set. The fixed volume can not exceed the maximum volume setting. Default power setting can be off, follow Main, or independent. If set as independent, Zone B will remain on if on when the Main Zone is powered off.

## Source

### SETUP>Source

The Source menu allows you to add, delete, edit and arrange sources.

To add a source, select the “Add source” button in the top right corner of the menu. This will bring up options for the source. You will see these same options when selecting to **edit an existing source**. The options are:

- Source name: this will be the name that will

display for this channel. Customize at will.

- Lipsync offset: values between 0ms and 500ms can be set as a lipsync delay to match audio and video playback.
- Volume offset: values between -20dB and +20dB can be set to compensate for different Input levels from different sources.
- Audio Input: select from a list of available sources to assign to this Input. If you want the audio Input to match the video Input from an HDMI source, select HDMI Audio.
- Postprocessing: set the default postprocessing mode from a list. Choose “none” for no processing or “no change” to not alter the current processor when this Input is chosen.
- Default voicing: select the default voicing for this Input from a list. Choose “no change” to keep current voicing when this Input is chosen.
- Video Input: choose from a list of available HDMI sources or none to assign to this Input.
- Data out: you can assign any one of the four Data Out ports to send control data to connected components when this Input is chosen. See “Figure 11– Speaker setup screen” on page 14.
- IR command: you may choose an available component name from a list to assign the source to an Input name that could be used for controlling the unit by a control system. For example, if HDMI 2 was assigned to “DVR”, then a control device sending the DVR command would select HDMI 2 on the MX170.
- Trigger out: A trigger can be assigned to the Input. Available triggers are controlled in the trigger setup menu. A trigger not assigned to



a source (Source, Source A or Source B) will not appear as an option. (See “Trigger Setup” on page 18.)

Select Save to keep changes.

## Video Setup

The Video setup menu has two sub menus: Video Output and Video Input.

## Video Output

### SETUP>Video setup>Video output

This menu manages the default and preferred setting for all video Outputs. In most cases the factory default settings are recommended.

Choose an Output to be the MX170’s main video Output. Other Outputs can be configured to “Follow main”.

For each HDMI Output and the HDBT OUT, the following settings can be changed:

**Preferred resolution:** The default of none will allow the MX170 to negotiate the best resolution supported by the video display. Specific resolutions can be specified, but the MX170 does not scale the resolution and will pass the source’s resolution.

**Default video source:** the Output can be set to follow the main video Output or set to any of the eight HDMI Inputs. Choose “Independent” if the Output will be controlled externally such as from an RS232 connection.

**HDMI Audio out:** The default setting is Passthrough which will send the audio from the source. Audio can also be changed to Off or Zone B audio can be selected for second zone applications. USB or HDMI Inputs will not work for Zone B HDMI.

The HDBT (HDBaseT) connection allows there

to be very long cable runs between the MX170 and a monitor. CAT6 or greater cable with RJ45 connector can be used for distances up to 328 feet (100m). Settings work the same as the other four HDMI Outputs.

## Video Input

### SETUP>Video setup>Video Input

In this menu, each of the eight HDMI Inputs can be customized as to what information is advertised to the sources. The HDMI Inputs send EDID (Extended Display Identification Data) to the source to negotiate acceptable formats.

In the Video setting section, the following options are available for the various resolutions:

- Always - always advertise support for the given resolution, regardless the supported Outputs of any connected TV
- Never - never advertise support for the given resolution, regardless of what the supported resolutions of any connected TVs are
- One - advertise support for the given resolution, if one of the TVs on the Outputs support the resolution
- All - advertise support for the given resolution, if all the TVs on the Outputs support the resolution

If All is selected for HDR and one of the TVs is not HDR compliant, then HDR functionality may be disabled for all. Select One or Always in this case. With Always, a non-HDR TV may not like the HDR signal.

For the Audio setting, any selection other than “PCM, bitstream, multichannel” will require the source to do the decoding. Choices for audio advertised to the source are:

- PCM only, multichannel (default)
- PCM stereo only
- PCM stereo up to 48kHz only

The HDCP (High-bandwidth Digital Content Protection) compatibility should generally be left as the default setting HDCP 2.2 unless you are experiencing difficulties with this setting. If there are sources that have difficulties with this, you can select from these other settings:

- HDCP 1.4 – only advertise HDCP 1.4 support
- No DDC – there will be no communication on the DDC (Display Data Channel), so the source cannot read the EDID. This will also disable HDCP handshakes (units will not exchange authorization info)
- Sink – the MX170 will look like a TV to the source. As some sources have very bad repeater support, they do not function properly with a processor like the MX170, and this setting will bring the source to Output a picture

Select Save to keep changes.

## System Configuration

The System Configuration menu has three sub menus: General setup, Trigger setup and Network setup.

## General Setup

### SETUP>System configuration>General setup

**Power management** has two modes:

- Network- this allows the MX170 to be turned on through the network interface or a control system
- Deep sleep- this prevents remote powering of the MX170



Enter the number of minutes of inactivity before the MX170 enters the chosen standby mode. Enter “0” to disable the standby feature.

**Default volume settings** allow a maximum volume to be set above which the MX170 can not be set.

You also can set whether the MX170 starts up with the last volume played or set a value for the unit to start up with each time.

**Show bypass** will show or hide the choice of bypassing RoomPerfect™ settings in the trim menu under RoomPerfect™. Select “Yes” to make the bypass choice available or “No” to remove the menu option.

**Display timeout** sets a number of seconds for the display to dim after changing a setting or Input. To disable the dimming of the display choose “0”.

**Password** allows password protection of the web interface menu. This prevents accidental or unauthorized changes being made to the MX170 through the web interface. The interface is still available to control the Main Zone and Zone B.

To password protect the setup menu, select “Yes” and then place the MX170 in standby. The next time it is powered on, the setup menu will be protected.

To enter the setup menu when password protected, the IP address must be followed by “/setup” (for example 192.168.1.127/setup). When prompted for a password enter “7800.”

**Enable front IR** sensor allows you to turn the front IR sensor of the unit on and off. This may be helpful if the IR codes of another unit are conflicting with the MX170.

### HDMI CEC settings

Consumer Electronics Control (CEC) is a feature of HDMI that theoretically allows users to control multiple connected devices through one Remote Control. This can work fine in some cases when you want to turn on the television and also power on

other related devices, but there may be times when you do not want this or other connected events to happen. You can Disable HDMI CEC if desired.

With CEC enabled you can choose to **Enable SAC** to allow the volume control of the TV to control the audio volume.

**If you plan on using ARC (Audio Return Channel), CEC must be enabled** and the Audio Input of an HDMI channel should be set to Audio Return Channel. (SETUP>Source>HDMI x> Edit> Audio Input.)

**OSD info level** gives three options for the amount of information shown on attached displays:

- Show all will display change of Input and change of volume
- Show volume will display the volume level when changed
- Show nothing will do just that

## Trigger Setup

### SETUP>System configuration>Trigger setup

Trigger setup allows you to control what devices control other components power status. Zone A and Zone B trigger Outputs are tied to their respective zones, but Trigger 1 and Trigger 2 can be configured as follows:

- Off – No action
- Source – When the preset source for any zone is selected, it will trigger. Use source setup menu to associate with a source. (See “Source” on page 16)
- Source A – When the preset source for Zone A/Main Zone is selected, it will trigger
- Source B - When the preset source for Zone B is selected, it will trigger
- Power A – When Zone A/Main Zone is On, it will trigger

- Power B - When Zone B is On, it will trigger
- Power any - When any Zone is On, it will trigger

## Network Setup

### SETUP>System configuration>Network setup

Network setup has a Manual and Auto setting. The Auto setting is simplest in that the MX170 will be assigned an IP address from your router and all the pertinent information will automatically be filled. If you are familiar with networks, you may prefer to assign an IP address. The advantage to this is that you will have a fixed unchanging IP address of your choosing.

Choosing Manual setup will allow you to edit the IP Address, Subnet mask, Gateway and DNS fields.

The assigned IP address of the MX170 can be found by pushing the DISPLAY MODE button (see “Display Mode” on page 13).

Select Save to keep any changes.

## Manage Software

The Manage software menu has two sections:

- Information
- Backup & Restore

The Information Menu has three sub-menus:

### SETUP>Manage software>Software information

Software information- Here you will find version numbers for various software used in the MX170. This is helpful in some troubleshooting situations.

### SETUP>Manage software>Network information

Network information- This menu provides a summary of various network addresses.

### SETUP>Manage software>Download system log

Download system log- This menu allows you to download the MX170's system log which provides detailed information about the performance of the MX170. This can be helpful to service personnel in case of difficulties. Simply select "Download system log" for a copy of the log.

**For information on the Backup & Restore sub-menu see "Backup and Restore" on page 22.**

This sub-menu includes Backup, Restore, Factory Reset and Update software.

## Dolby Atmos and Auro-3D Setup Examples

The system supports Dolby Atmos as well as Auro-3D. If Dolby Atmos material is played in an Auro-3D setup, the system will try to match the Auro-3D specific speakers to the nearest Dolby Atmos equivalent; the same goes for playing Auro-3D material on a Dolby Atmos setup. The system will also handle hybrid setups with both types of speakers.

DTS will work with a variety of setups including the Auro 3D setup below without using the TOP speaker.

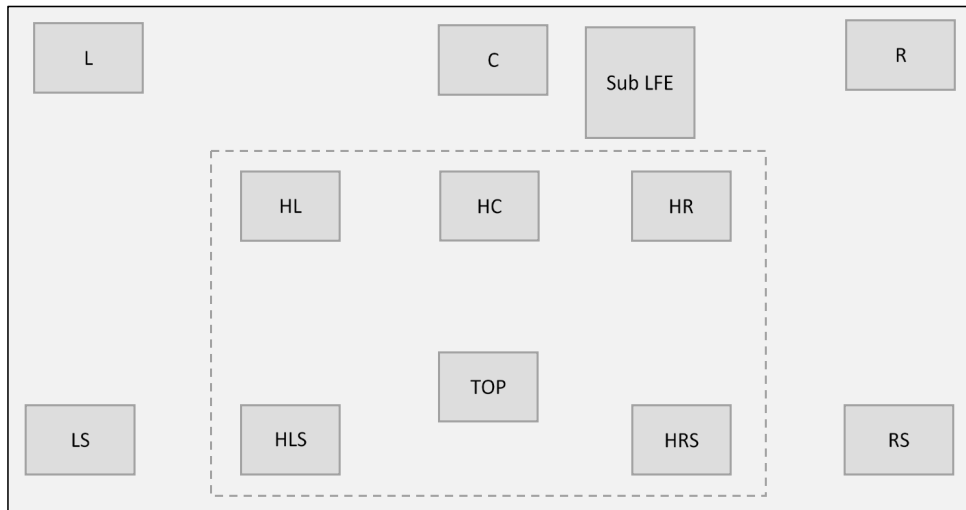

Figure 12– Auro-3D example: 11.1

*If Dolby Atmos material is played on the above Auro-3D setup, the system will match the speakers, so the LTF/RTF channels are played through the HL/HR speakers and the LTR/RTR channels are played through the HLS/HRS speakers. The HC and TOP speakers will not be used.*

## Dolby-enabled speakers

For Dolby Atmos setups, it is possible to add Dolby Enabled Speakers instead of using top speakers mounted in the ceiling.

Dolby Enabled Speakers are extra speakers placed on top of or built into the speakers on the main positions in the system (front, surround and rear surround). These extra speakers fire sound upwards toward the ceiling. The sound is then reflected to give the listener the sound from above without having actual top speakers installed.

To add Dolby Enabled Speakers to your system, select the speakers which the Dolby Enabled Speakers are associated with. For instance, if you have Dolby Enabled Speakers on top of your front and surround speakers, go to the settings for these speakers and activate the Dolby Enabled Speaker option. This will then give you the option to select the size of the Dolby Enabled Speaker. Once this is done, the system will find out which signal is to be routed for this speaker and will add an Output for it.

Notice that playback of Auro-3D material will not make use of Dolby Enabled Speakers.

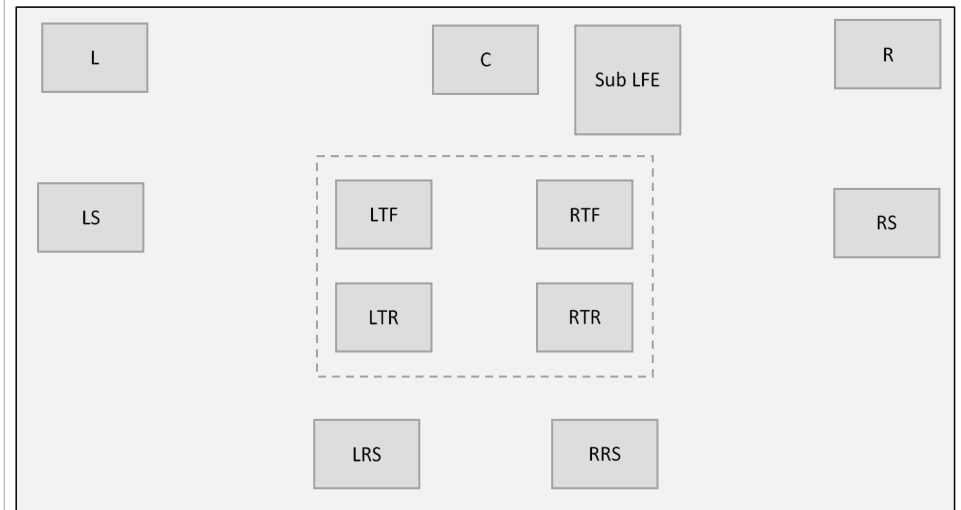

Figure 13– Dolby Atmos Example: 7.1.4

*If Auro-3D material is played on this setup, the system will play the HL/HR channels through the LTF/RTF speakers and the HLS/HRS channels through the LTR/RTR speakers. The LRS and RRS speakers will not be used.*

## Bass Management Examples

The following examples show a few different possible setups and how the bass is routed in them. The examples only mention where the LFE channel and the redirected bass is played; the high part of any channel is always played by the speaker for that channel. The same goes for bass that is not redirected, so this will not be specifically mentioned. Figure 14 represents a more or less typical system.

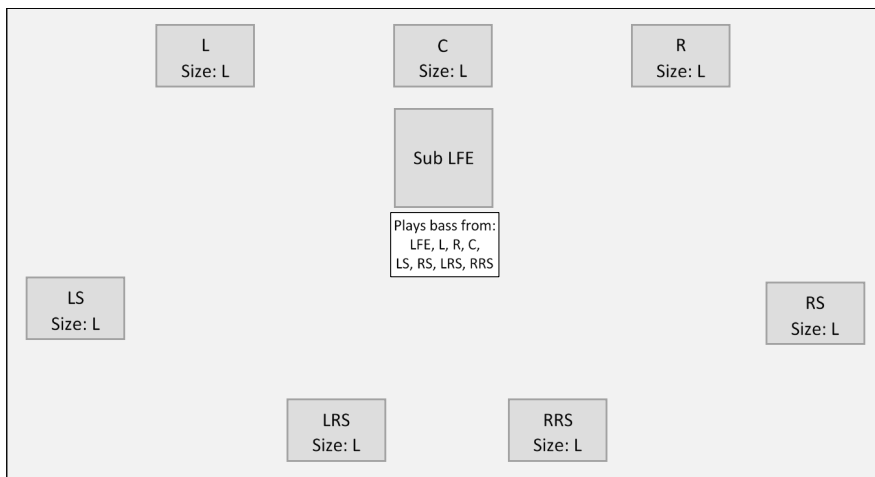

Figure 14– 7.1.4 LFE Sub

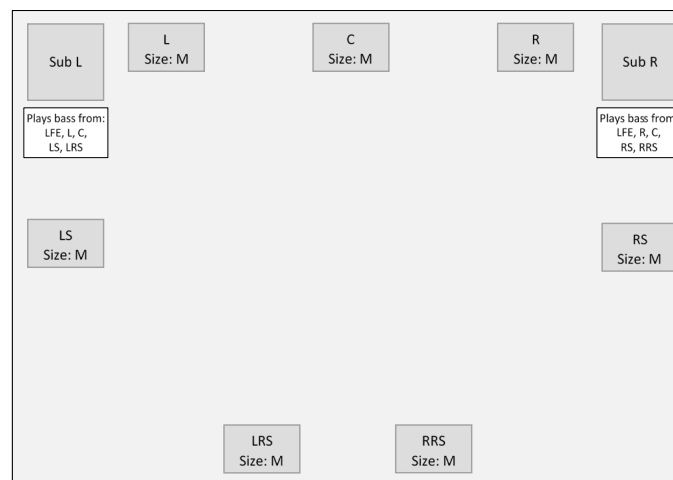

Figure 16– 7.1.4 Front Subs

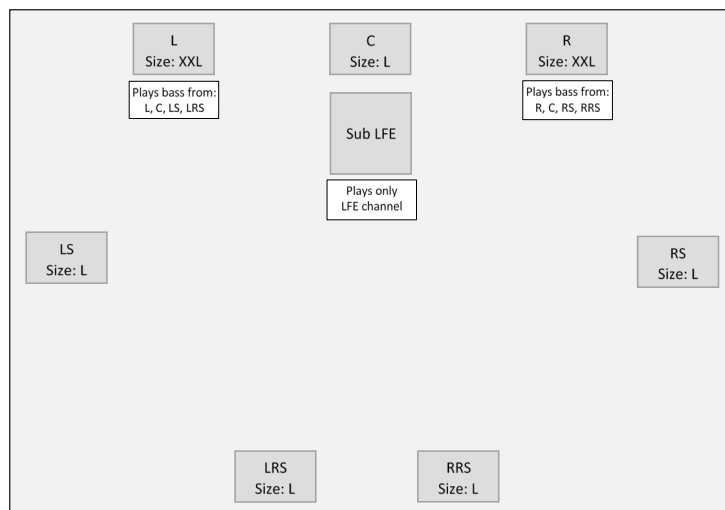

Figure 15– 7.1.4 LFE Sub, Front XXL Speakers

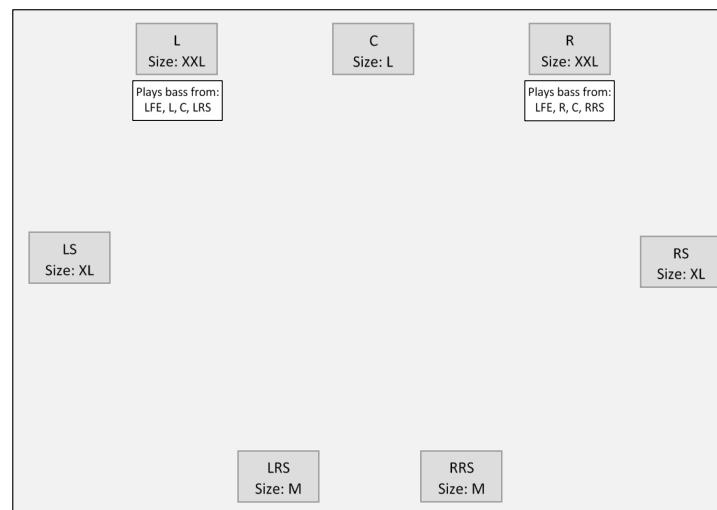

Figure 17– 7.1.4 Front Speakers, XL Surrounds

## Description of Remote Control Buttons

LEDs illuminate during the time a remote command is sent and when programming the Remote Control

Select the DEVICE to issue a Remote Control command to

SETUP Push-button selects the Installer Menu

Selects AM Tuner Operating Functions (when connected to a McIntosh), also Track Selection on certain McIntosh CD Players

Press the Trim Push-button and then the LEVEL UP Push-button to select and adjust various functions. MENU is used with McIntosh Models displaying choices on a video screen

Activates the TRIM Mode. GUIDE is used with McIntosh Models displaying instructions on a video screen

Press the Trim Push-button and then the LEVEL DOWN Push-button to select and adjust various functions. INFO is used with McIntosh Models displaying information on a video screen

Scrolls through the available Inputs

Mutes the audio

Selects transport functions of STOP, PLAY/PAUSE, RECORD, BACK for the previous-selection, FAST-REVERSE, FAST-FORWARD and NEXT for the next selection

Selects Previous Tuner Station PRESET

Tuner scans Down the dial to SEEK the next Station

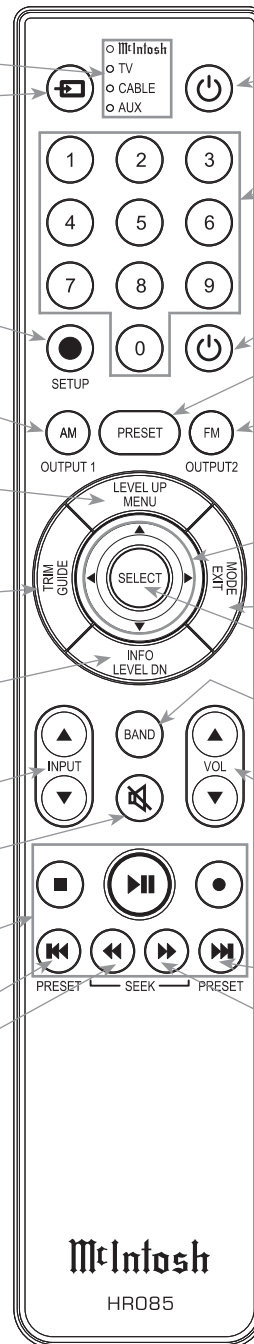

Press to Power the amplifier ON

Use to select tuner presets, direct access an AM/FM Station Frequency, disc tracks or any numbered operation

Press to Power the amplifier OFF

Direct access to stored Tuner PRESETS when used with the numeric Push-buttons (0 thru 9)

Selects FM Tuner Operating Functions (when connected to a McIntosh), also Track Selection on certain McIntosh CD Players

Use ▲ and ▼ to tune Up or Down the AM/FM Dial, use ► and ◀ for the next or previous HD Radio Program (McIntosh HD Tuner)

EXIT is used with McIntosh Models displaying information or choices on a video screen

Used to SELECT/Enter the indicated choice

Press to change broadcast BANDs on a connected Tuner. Select certain functions on a variety of McIntosh Models

Adjusts the VOLume level up or down

Selects Next Tuner Station PRESET

Tuner scans Up the dial to SEEK the next Station

*Note: Push-buttons whose function is not identified above are for use with other McIntosh Products.*

## Remote Control Batteries

The HR085 Remote Control included with the MX170 is powered by two AAA batteries. To insert or remove batteries, open the battery compartment by removing the cover located on the back of the remote. To open, pull the clasp located just above the opening downward.

## RoomPerfect™ Setup

RoomPerfect™ is an intelligent system which will fine-tune your system to properly interact with the

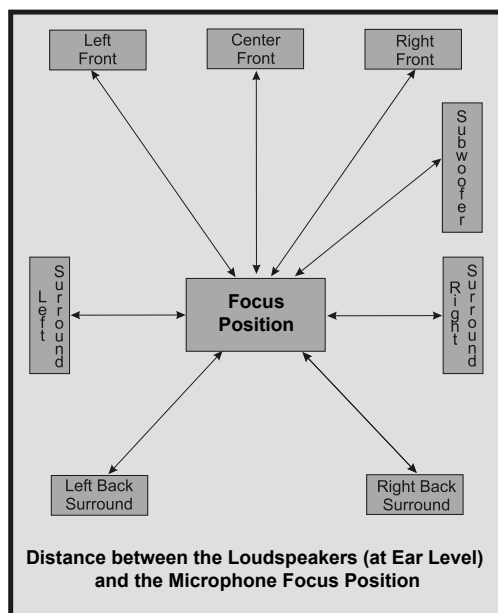

Figure 18– RoomPerfect™ Focus Position

room’s acoustics through precise calibration. This will get the highest possible performance from your complete system providing a tighter and more detailed sound with increased imaging.

The RoomPerfect™ Measure and Adjustment Process uses multiple measurement locations in the listening room to achieve the best possible acoustical results. The Focus Position (location in the room) is typically where one would be during serious viewing/listening.

To prepare for measuring:

- Assemble the supplied microphone stand with attached boom and microphone clip (holder) and place the microphone on the clip
- Connect the Microphone to the MX170 MIC Input on the Rear Panel using the supplied microphone (XLR) cable
- Place the microphone at the Focus Position for the initial measurement
- Set trim controls to the flat setting position
- Try to minimize external noises by shutting windows and unnecessary noise producing equipment
- Make sure speakers have been setup and “Verify Speakers” has been run

Open the Setup menu on the browser window for the MX170. The address will be something like <http://192.168.1.121/setup> with your actual IP address used. (You can find your IP address by pushing the DISPLAY MODE button until the IP address appears on the LED screen.)

*Setup can also be performed using an HDMI attached monitor and the Remote Control. Arrow keys can navigate the screens.*

- Select “Speakers & Room” from the menu located on the left
- Select “RoomPerfect™ ” from the drop down menu

You will be asked to enter speaker distances from the

Focus Position if this information was not previously entered. The more accurate these measurements are, the more precise 3D effects will be. A laser measure may be a helpful tool to measure the distance from speaker to the exact Focus Position.

Test signals will be run to set the proper testing volume. Adjust the volume as necessary to achieve target volume.

Once target volume is set, RoomPerfect™ will begin playing a series of tones.

When the test is complete, move the microphone to a random spot in the room. Use various heights and positions at least 2 feet from other test locations. Do not test behind front speakers.

Each location will add more information. Continue until the room knowledge is in the upper 90 percent range.

When satisfied, choose “Done”. You will be given the opportunity to backup the MX170 to a USB or SD card.

When the RoomPerfect™ measurements are completed and implemented, the RoomPerfect™ LED will illuminate on the MX170 front panel.

## Backup and Restore

The MX170 A/V Processor allows you to save setup information including RoomPerfect™ settings. After investing time in setting up your system, it is recommended that you save your settings.

To Save settings:

- Insert a USB drive in the USB 1 or 2 slot or use the SD-card inserted from the factory (or replace that SD-card)
- In the SETUP menu of the MX170, choose “Manage software” and then choose “Backup”

- Choose “USB” or “SD-card” for backup location
- Choose “Start Backup”
- A “Creating backup” progress meter will display. The MX170 will reboot when complete

To restore settings:

- With the backup source inserted, choose “Manage software” from the SETUP menu
- Choose “restore”
- Select the backup file from the appropriate source. Note that restoring from an SD-card requires running the setup program from the MX170 front panel. USB restoration can be run from a browser as well as from the front panel
- Choose to retain current software version or restore software version from the backup
- Choose “Start restore”

When the restore completes, the MX170 will shut down.

## Factory Reset

Use the Factory Reset option to restore the MX170 back to its original factory defaults. This option will erase all changes made to settings. The firmware will remain the latest installed version.

To perform a Factory reset:

- Go to the SETUP MENU
- Choose “Manage software”
- Choose “Factory Reset”
- Choose “Start factory reset”
- When complete, the MX170 will shut down

## Update Software

The Update Software feature allows for the latest firmware version to be easily installed on the MX170.

To update the firmware version of the MX170:

- Go to the SETUP MENU
- Choose “Manage Software”
- Choose “Update software”

If you are using a browser to access SETUP, there are three possible locations to choose the update file from:

- “Remote server” will display the latest officially released version
- “Select file from USB” will show files located on an inserted USB drive
- “Browse” will allow you to search the computer and connected drives for the file

If you access SETUP from the front panel, then “Remote server” and files from a local USB drive will be your two update options.

- Select the file you wish to install
- Choose Start update

The MX170 will install the update and then shut down. Do not manually power off the unit while installing the update.

**In the ever changing world of high-resolution video and audio, there are often updates needed to stay current. We recommend that your MX170 be connected to the internet for updates. It is also important that other components in your A/V environment that offer updates be kept current. This will help your system continue to operate at peak performance.**



## Re-packing the MX170

When shipping the MX170, it is highly recommended that the unit be packed as it was originally shipped to avoid damage. Failure to properly pack the unit will likely result in damage. (The front panel is made of glass!) If you need any of the packing material, you can contact McIntosh Customer Service (see page 2). Use only packing material that is in good condition and replace non-servicable material.

It is very important that the four plastic feet are attached to the bottom of the equipment. This will ensure the proper equipment location on the bottom pad. Failure to do this will result in shipping damage.

| Quantity           | Part Number | Description          |
|--------------------|-------------|----------------------|
| 1                  | 034256      | Shipping carton only |
| 4                  | 033887      | End cap              |
| 2                  | 034493      | Spacer pad           |
| Inside carton only |             |                      |
| 1                  | 033697      | Inner carton top pad |
| 1                  | 034576      | Bottom pad           |
| 2                  | 034446      | Foam plug            |
| 4                  | 017937      | Plastic foot         |
| 4                  | 400159      | #10-32 x 3/4" screw  |
| 4                  | 404080      | #10 Flat washer      |
| 1                  | 034499      | Accessory Box        |
| 2                  | 034500      | Slotted foam         |
| 1                  | 034501      | Divider foam         |

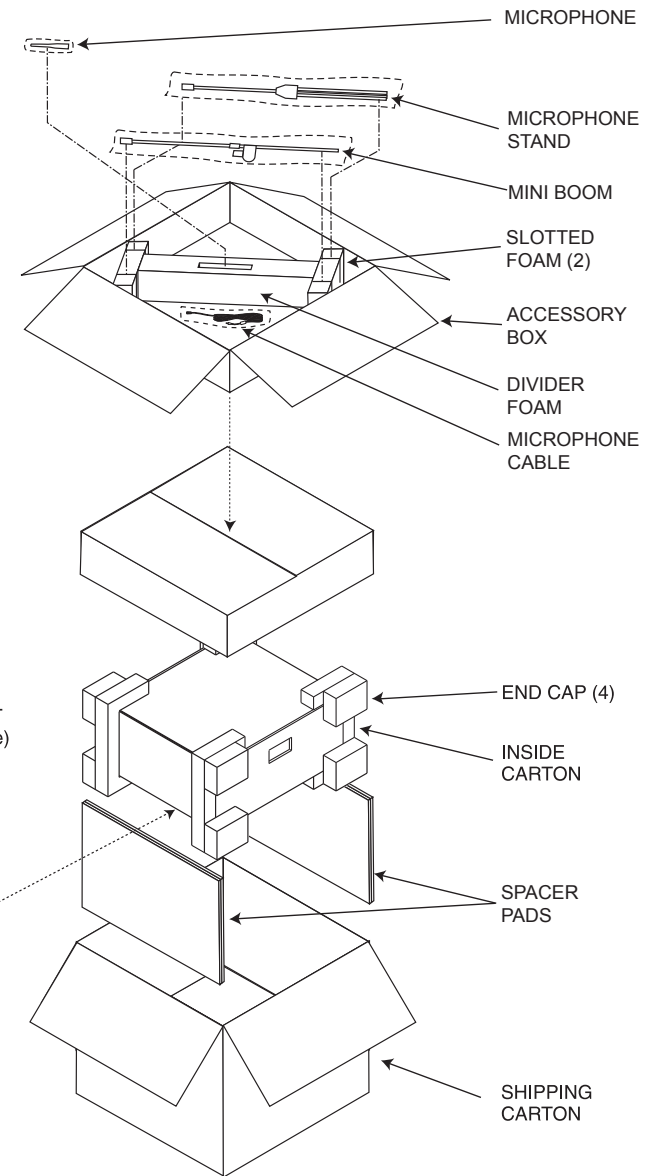
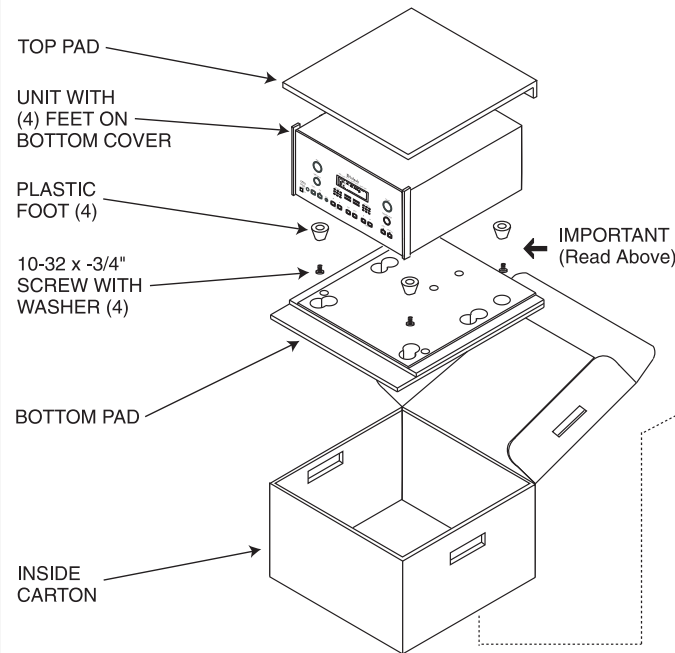



---

## Technical Specifications

---

Unless otherwise noted, the below MX170 Specifications were taken with RoomPerfect™ set to Bypass Mode and Voicing Mode set to Neutral.

### Frequency Response

Left, Center, Right, Left Surround, Right Surround, Left Back Surround, Right Back Surround:  
±0.5dB from 20Hz-20,000Hz  
Subwoofer:  
±0.5dB from 20Hz-8000Hz

### Total Harmonic Distortion

0.005% maximum from 20Hz to 20,000Hz at rated Output

### Signal To Noise Ratio

Phono: 86dB below 10mV Input (A Weighted)  
High Level: 96dB below rated Output (A Weighted)

### Rated Output Voltage

2.5V Unbalanced Outputs (Main)  
5.0V Balanced Outputs (Main)

### Maximum Voltage Output

6.5V Unbalanced (8.5V Subwoofer)  
13V Balanced (17V Subwoofer)

### Output Impedance

75 ohms Unbalanced  
100 ohms Balanced

### Input Impedance

Phono: 47k Ohms, 65pf  
High Level: 10k Ohms Unbalanced and Balanced

### Sensitivity for Rated Output

Phono: 5mV  
High Level: 500mV Unbalanced  
1V Balanced

### Maximum Input Signal

Phono: 50mV  
High Level: 5V Unbalanced and Balanced

### Tone Controls

Bass Control: ±10dB at 30Hz  
Treble Control: ±10dB at 10,000Hz

### HDMI/Coaxial/Optical Digital Input Rate

32kHz to 192kHz, 24-Bit, Dolby Digital, DTS

### Power Requirements

100 Volts, 50/60Hz at 100 watts  
110 Volts, 50/60Hz at 100 watts  
120 Volts, 50/60Hz at 100 watts  
127 Volts, 50/60Kz at 100 watts  
220 Volts, 50/60Hz at 100 watts  
230 Volts, 50/60Hz at 100 watts  
240 Volts, 50/60Hz at 100 watts  
Standby, less than 0.5 watt

*Note: Refer to the rear panel of the MX170 for the correct voltage.*

### Overall Dimensions

Width is 17-1/2 inches (44.5cm)  
Height is 7-5/8 inches (19.4cm) including feet  
Depth is 19-1/2 inches (49.53cm) including the Front Panel, Knobs, Rear Panel Connections and USB Drive

### Weight

30 pounds (13.6Kg) net, 54 pounds (24.5Kg) shipping

### Shipping Carton Dimensions

Width is 25 inches (63.5cm)  
Depth is 28 inches (71.12cm)  
Height is 18-3/8 inches (46.67cm)



## Voicing Curves

Here are examples of default Voicing equalization curves included with the MX170. Voicings are accessible through the Voicing trim settings. Default equalization curves can be edited. New curves can be designed using multiple filters. Custom Voicings can be selected the same manner as default Voicings using the TRIM SELECT knob (see “Trim Select Knob” on page 12).

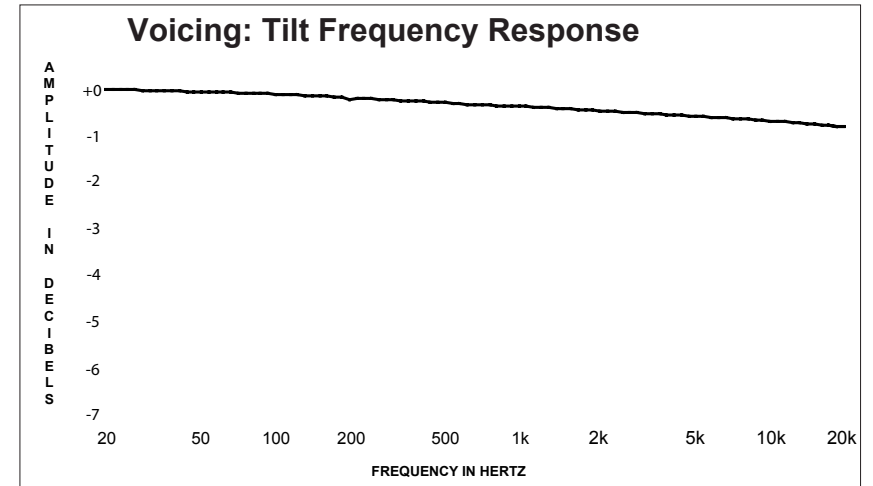
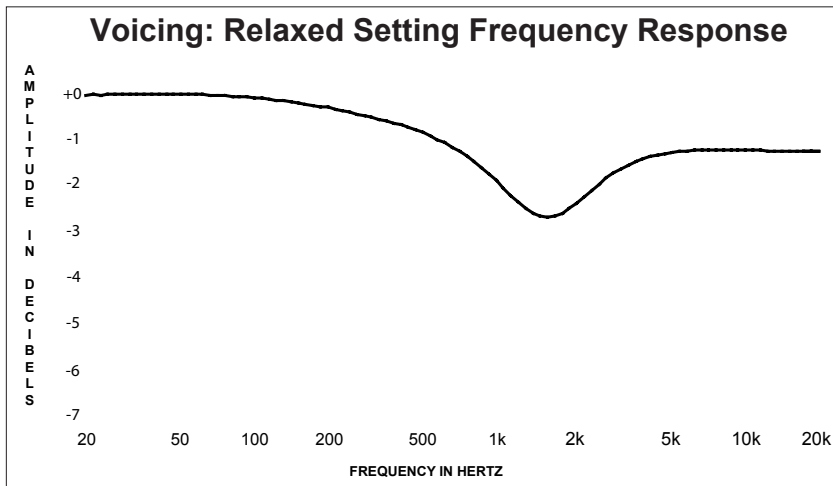
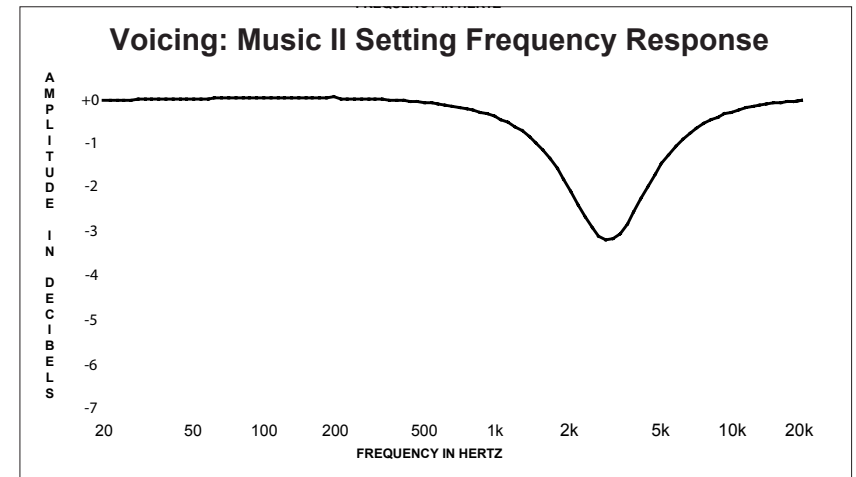
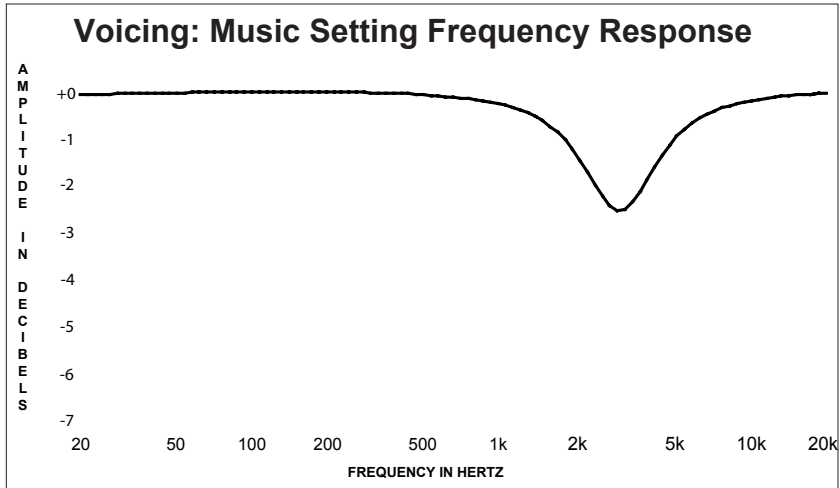





McIntosh Laboratory, Inc.  
2 Chambers Street  
Binghamton, NY 13903  
[www.mcintoshlabs.com](http://www.mcintoshlabs.com)

The continuous improvement of its products is  
the policy of McIntosh Laboratory Incorporated  
who reserve the right to improve design without  
notice.

Printed in the U.S.A.