



McIntosh Laboratory, Inc. 2 Chambers Street Binghamton, New York 13903-2699 Phone: 607-723-3512 www.mcintoshlabs.com

# MX123

A/V Processor

Owner's Manual





**The MX123 Audio/Visual Processor marries a long tradition of uncompromising quality with the latest home theater technologies to bring you an unsurpassed luxury entertainment experience.**

---

## Thank you from all of us at McIntosh

---

You have invested in a precision instrument that will provide you with many years of enjoyment. Please take a few moments to familiarize yourself with the features and instructions to get the maximum performance from your equipment.

If you need further technical assistance, please contact your dealer who may be more familiar with your particular setup including other brands. You can also contact McIntosh with additional questions or in the unlikely event of needing service.

**McIntosh Laboratory, Inc.**  
 2 Chambers Street  
 Binghamton, New York 13903  
 Technical Assistance: (607) 723-3512  
 Customer Service: (607) 723-3515  
 Fax:(607) 724-0549  
 Email: support@mcintoshlabs.com  
 Website: mcintoshlabs.com

---

## Make a Note

---

For future reference, you can jot down your serial number and purchase information here. We can identify your purchase from this information if the occasion should arise.

Serial Number:	
Purchase Date:	
Dealer Name	

## List of Figures

Figure 01– MX123 Dimensions.....	6
Figure 02– Custom cutout dimensions.....	7
Figure 03– “L” bracket screws.....	7
Figure 04– MX123 Rear View.....	8
Figure 05– Mini plug for RS232 connection.....	9
Figure 06– DB9 connector pin layout.....	9
Figure 07– IR 3.5mm connector.....	9
Figure 08– Setting the Remote Control Lock.....	9
Figure 09– Power control (trigger) mini plug.....	11
Figure 10– Power control (trigger) mini plug.....	11
Figure 11– MX123 Front panel.....	12
Figure 12– Display in Setup Mode.....	14
Figure 13– Browser Setup Menu.....	14
Figure 14– Sample Browser Warning screen.....	15
Figure 15– Speaker Positions and abbreviations.....	17
Figure 16– Auro-3D layout example.....	17
Figure 17– Dolby Atmos Enabled speakers.....	18
Figure 18– Audyssey® main listening position..	28
Figure 19– Speaker angles.....	28
Figure 20– Audyssey® Setup Start.....	29
Figure 21– Audyssey® Begin Test.....	29
Figure 22– Speaker Detection.....	29
Figure 23– Microphone positioning.....	29
Figure 24– Measurements complete.....	30
Figure 25– Dynamic EQ.....	30
Figure 26– Audyssey® error message.....	30
Figure 27– Audyssey® restore.....	30
Figure 28– Error table.....	31
Figure 29– Re-packing diagram.....	34

## Table of Contents

Thank you from all of us at McIntosh .....	2	Sleep Timer .....	13	Hide Sources .....	23
Make a Note .....	2	Changing GUI Language/Video Format .....	13	Source Level .....	23
Safety First .....	4	LED Channel Status Indicators .....	14	Input Select .....	23
Trademark and License Information .....	5	Setup .....	14	Network .....	24
What is in the box .....	6	The Setup Menu .....	14	General Setup .....	24
Where to put it .....	6	Browser Security Warning .....	15	Save & Load .....	25
Making the Cuts .....	7	Speakers- Setup Menu .....	15	Description of Remote Control Buttons .....	26
Securing the MX123 to a Shelf .....	7	Amp Assign .....	15	Firmware .....	26
Connections on the Back .....	8	Speaker Types and Positions .....	16	Remote Control Batteries .....	28
The Inputs .....	8	Speaker Configuration .....	17	Audyssey® .....	28
The Outputs .....	8	Speaker Distances .....	18	Audyssey® Setup .....	28
Making Connections .....	8	Speaker Levels .....	18	Error Messages .....	30
Bluetooth/Wi-Fi Antenna .....	8	Crossovers .....	18	Factory Reset .....	31
10baseT LAN .....	8	Bass .....	18	Bluetooth .....	32
HDMI .....	9	Front Speaker .....	19	The Option Button .....	32
USB .....	9	2 Channel Playback .....	19	The Headphone Question .....	32
Microphone .....	9	Audio- Setup Menu .....	19	Online Music .....	32
RS232 .....	9	Subwoofer Level Adjust .....	19	Spotify Connect .....	32
Wired IR Inputs .....	9	Bass Sync .....	19	Compatible Audio Formats .....	32
Digital Inputs .....	10	Sound Parameter .....	19	Supported Video Signals .....	33
Analog Audio Inputs .....	10	DFR .....	19	USB File and Folder Limits .....	33
AC Power .....	10	Audio Delay .....	19	About ARC and CEC .....	33
Balanced Audio Outputs .....	10	Volume Setup .....	19	Packing the MX123 .....	34
Power Control (Trigger) Outputs .....	11	Audyssey® Options Menu .....	20	Audio Specifications .....	35
Analog Audio Output .....	11	Video- Setup Menu .....	20	Video Specifications .....	35
Data Out .....	11	Picture Adjust .....	20	General Specifications .....	35
Setup Assistant .....	11	HDMI Setup .....	21		
The Front Panel .....	12	Output Settings .....	21		
Standby On .....	12	HDMI Video Output .....	21		
The Input Knob .....	12	Video Mode .....	22		
The Volume Knob .....	12	Video Conversion .....	22		
The Arrow and Enter Buttons .....	12	Analog Video Out .....	22		
Status .....	13	On Screen Display .....	22		
Sound Mode Buttons .....	13	4K Signal Format .....	23		
Zone Select .....	13	TV Format .....	23		
Zone On/Off .....	13	Inputs Setup Menu .....	23		
Dimmer .....	13	Input Assign .....	23		
		Source Rename .....	23		



## Safety First

### Important Safety Information is supplied in a separate document “Important Additional Operation Information Guide”

#### FCC Information (For US Customers)

##### 1. IMPORTANT NOTICE: DO NOT MODIFY THIS PRODUCT

This product, when installed as indicated in the instructions contained in this manual, meets FCC requirements. Modification not expressly approved by McIntosh may void your authority, granted by the FCC, to use the product.

##### 2. CAUTION:

- To comply with FCC RF exposure compliance requirement, separation distance of at least 20cm must be maintained between this product and all persons.
- This product and its antenna must not be co-located or operating in conjunction with any other antenna or transmitter.

##### 3. COMPLIANCE INFORMATION:

- Product Name: A/V Processor
- Model Number: MX123
- **This product contains FCC ID:RAX-AIOS4-0S:**  
McIntosh Laboratory, Inc.  
2 Chambers Street  
Binghamton, NY 13903  
Tel. (607) 723-3512

#### IC Information (For Canadian Customers)

##### 1. PRODUCT:

This product contains IC: 4711A-AIOS40S  
This product complies with RSS-210 of Industry Canada. Operation is subject to the following two conditions: (1) this product may not cause harmful interference, and (2) this product must accept any interference received, including interference that may cause undesired operation. This Class B digital apparatus complies with Canadian ICES-003.

##### 2. CAUTION:

To reduce potential radio interference to other users, the antenna type and its gain should be so chosen that the equivalent isotropically radiated power (e.i.r.p.) is not more than that permitted for successful communication.

#### Informations sur IC (pour les clients Canadiens)

##### 1. APPAREIL:

###### Cet appareil contient IC: 4711A-AIOS40S

Cet appareil est conforme à la norme CNR-210 du Canada. L'utilisation de ce dispositif est autorisée seulement aux deux conditions suivantes : (1) il ne doit pas produire de brouillage, et (2) l'utilisateur du dispositif doit être prêt à accepter tout brouillage radioélectrique reçu, même si ce brouillage est susceptible de compromettre le fonctionnement du dispositif. Cet appareil numérique de la classe B est conforme à la norme NMB-003 du Canada.

##### 2. ATTENTION:

Afin de réduire le risque d'interférence aux autres utilisateurs, il faut choisir le type d'antenne et son gain de façon à ce que la puissance isotrope rayonnée équivalente (p.i.r.e.) ne soit pas supérieure au niveau requis pour l'obtention d'une communication satisfaisante.

#### Canadian Customers: CAN ICES-3 (B)/NMB-3 (B) RF Exposure Information

This equipment complies with FCC/IC radiation exposure limits set forth for an uncontrolled environment and meets the FCC radio frequency (RF) Exposure Guidelines in Supplement C to OET65 and RSS-102 of the IC radio frequency (RF) Exposure rules. This equipment has very low levels of RF energy that are deemed to comply without testing of specific absorption ratio (SAR).

Cet équipement est conforme aux normes d'exposition aux radiations FCC/IC définies pour un environnement non contrôlé et satisfait les directives d'exposition à la radiofréquence (RF) dans le supplément C des OET65 et RSS-102 des règles d'exposition à la fréquence radio (RF) IC. Cet équipement a de très faibles niveaux d'énergie RF qui sont jugés conformes sans test de taux d'absorption spécifique (SAR).

#### R&TTE(EN) Information

##### 1. DECLARATION OF CONFORMITY

Our products follow the provisions of EC/EU directives:  
LV: 2006/95/EC  
EMC: 2004/108/EC  
RoHS: 2015/863/EU  
ErP: EC regulation 1275/2008 and its frame work directive 2009/125/EC  
R&TTE Directive 1999/5/EC.

##### 2. IMPORTANT NOTICE: DO NOT MODIFY THIS PRODUCT

This product, when installed as indicated in the instructions contained in this manual, meets R&TTE directive requirements. Modification of the product could result in hazardous Radio and EMC radiation.

##### 3. CAUTION:





Separation distance of at least 20cm must be maintained between this product and all persons.





**This product and its antenna must not be co-located or operating in conjunction with any other antenna or transmitter.**

## Trademark and License Information

The McIntosh MX123 incorporates copyright protected technology that is protected by U.S. patents and other intellectual property rights. The MX123 uses the following technologies:

This item incorporates copy protection technology that is protected by U.S. patents and other intellectual property rights of Rovi Corporation. Reverse engineering and disassembly are prohibited.

Trademark Logo	License Information
	Manufactured under license from Auro Technologies. Auro-3D® and the related symbols are registered trademarks of Auro Technologies. All materials contained in this work are protected by copyright law and may not be reproduced, distributed, transmitted, displayed, published or broadcast without the prior written permission of Auro Technologies NV or in case of third party materials, the owner of that content. You may not alter or remove any trademark, copyright or other notice from copies of the content. Auro Technologies: mail info@auro-technologies.com, phone +32-(0)-14314343, fax +32-(0)-14321224, www.auro-technologies.com.
	Manufactured under license from Dolby Laboratories. Dolby, Dolby Atmos, Dolby Audio, Dolby Surround, Dolby Vision and the double-D symbol are trademarks of Dolby Laboratories.
	HDMI, the HDMI Logo and High-Definition Multimedia Interface are trademarks or registered trademarks of HDMI Licensing LLC in the United States and other countries.
	The Bluetooth® word mark and logos are registered trademarks owned by Bluetooth SIG, Inc. and any use of such marks by McIntosh Laboratory is under license. Other trademarks and trade names are those of their respective owners.
	The Wi-Fi CERTIFIED Logo and the Wi-Fi CERTIFIED On-Product Logo are registered trademarks of the Wi-Fi-Alliance.

Trademark Logo	License Information
	Manufactured under license from Audyssey Laboratories™. U.S. and foreign patents pending. Audyssey MultEQ® XT32, Audyssey Dynamic EQ®, Audyssey Dynamic Volume® and Audyssey LFC™ are registered trademarks of Audyssey Laboratories.
	Apple, AirPlay, iPad, iPad Air, iPad Pro, and iPhone are trademarks of Apple Inc., registered in the U.S. and other countries. The trademark “iPhone” is used in Japan with a license from Aiphone K.K.
	Manufactured under license from IMAX Corporation. IMAX® is a registered trademark of IMAX Corporation in the United States and/or other countries. Manufactured under license from DTS, Inc. DTS, the symbol, DTS and the Symbol together, DTS:X, the DTS:X logo, Virtual:X, and the DTS Virtual:X logo are registered trademarks and/or trademarks of DTS, Inc. in the United States and/or other countries. © DTS, Inc. All Rights Reserved.
	The Spotify Software is subject to third party licenses found here: <a href="https://www.spotify.com/connect/third-party-licenses">https://www.spotify.com/connect/third-party-licenses</a> .



## What is in the box

Here is what is in the box besides all the shipping foam:

One MX123 A/V Processor

One accessory package including:

- Microphone with attached cable
- Microphone stand
- 1/2 inch male to 5/8 inch female adapter
- Two Bluetooth/Wi-Fi antennas

One hardware package:

- Two “L” Mounting brackets (for securing unit to shelf)
- Two screws #6 x 1/2 inch
- Four #6 washers

One manual package including this manual

One AC power cord

## Where to put it

The MX123 can be placed upright on a table or shelf, standing on its four feet. It also can be custom installed in a piece of furniture or cabinet. The four feet may be removed for custom installations. The four feet together with the mounting screws should be retained for possible future use. **Do not use different size screws** when re-installing the feet. With the feet removed, the MX123 requires a ventilation cutout. Dimensions for the panel cutout and bottom ventilation cutout are shown in Figure 02 on page 7.

Always provide adequate ventilation for your MX123. Cool operation ensures the longest possible operating life for any electronic instrument. Do not install the MX123 directly above a heat generating component such as a high-powered amplifier. If all the components are installed in a single cabinet, a

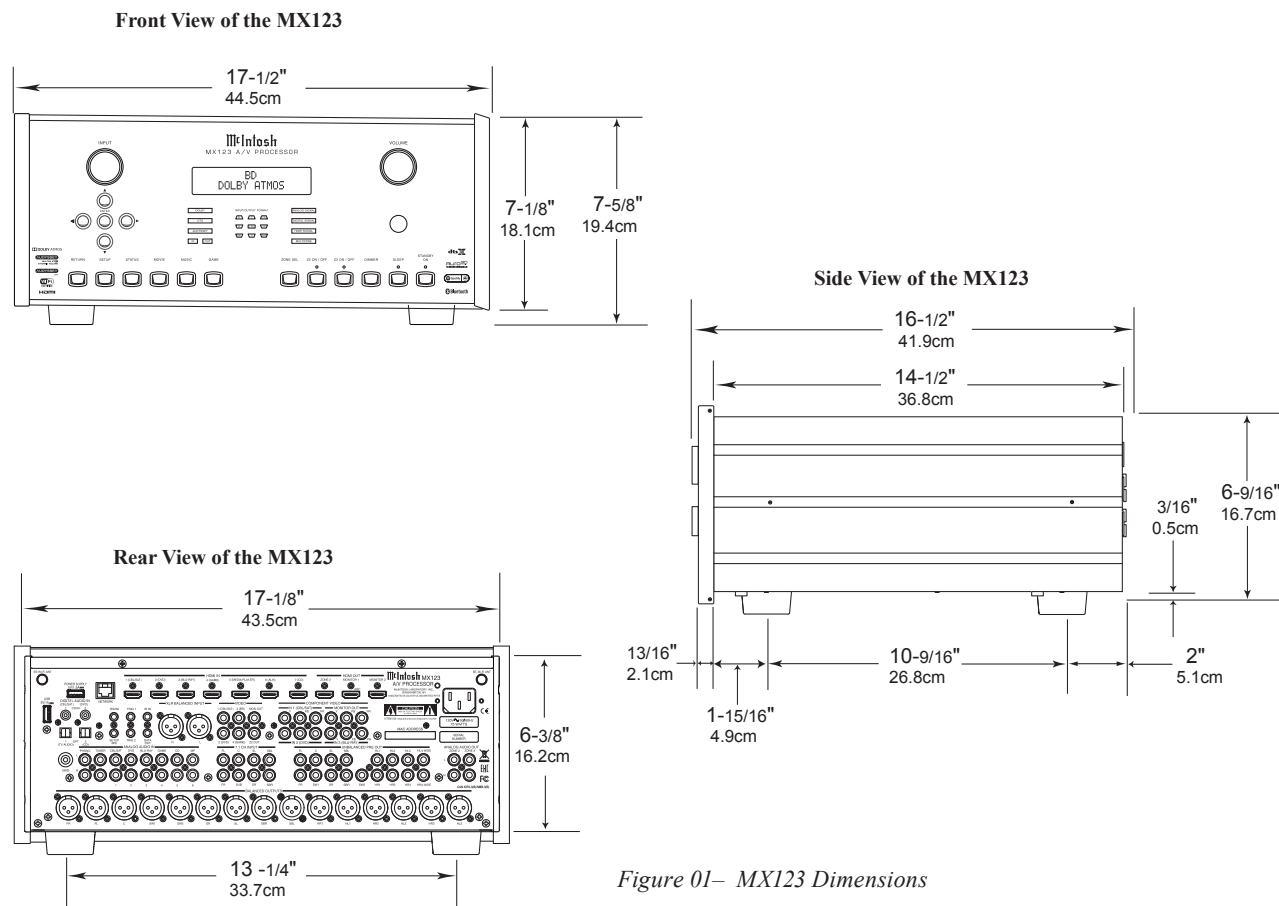

Figure 01– MX123 Dimensions

quiet running ventilation fan can be a definite asset in maintaining all the system components at the coolest possible operating temperature.

A custom cabinet installation should provide the following minimum spacing dimensions for cool operation:

- 2 inches (5.1cm) above the top
- 2 inches (5.1cm) below the bottom
- 1 inch (2.5cm) on each side of the MX123 so

that airflow is not obstructed

- 20 inches (50.8cm) depth behind the front panel
- 1-7/16 inch (3.7cm) in front of the mounting panel for knob clearance

Be sure to cut out a ventilation hole in the mounting shelf according to the dimensions in the drawing. See Figure 02 on page 7.

## Making the Cuts

Here are the dimensions for the cutouts needed for custom installation. A ventilation opening is essential

for any installation with the four feet removed.

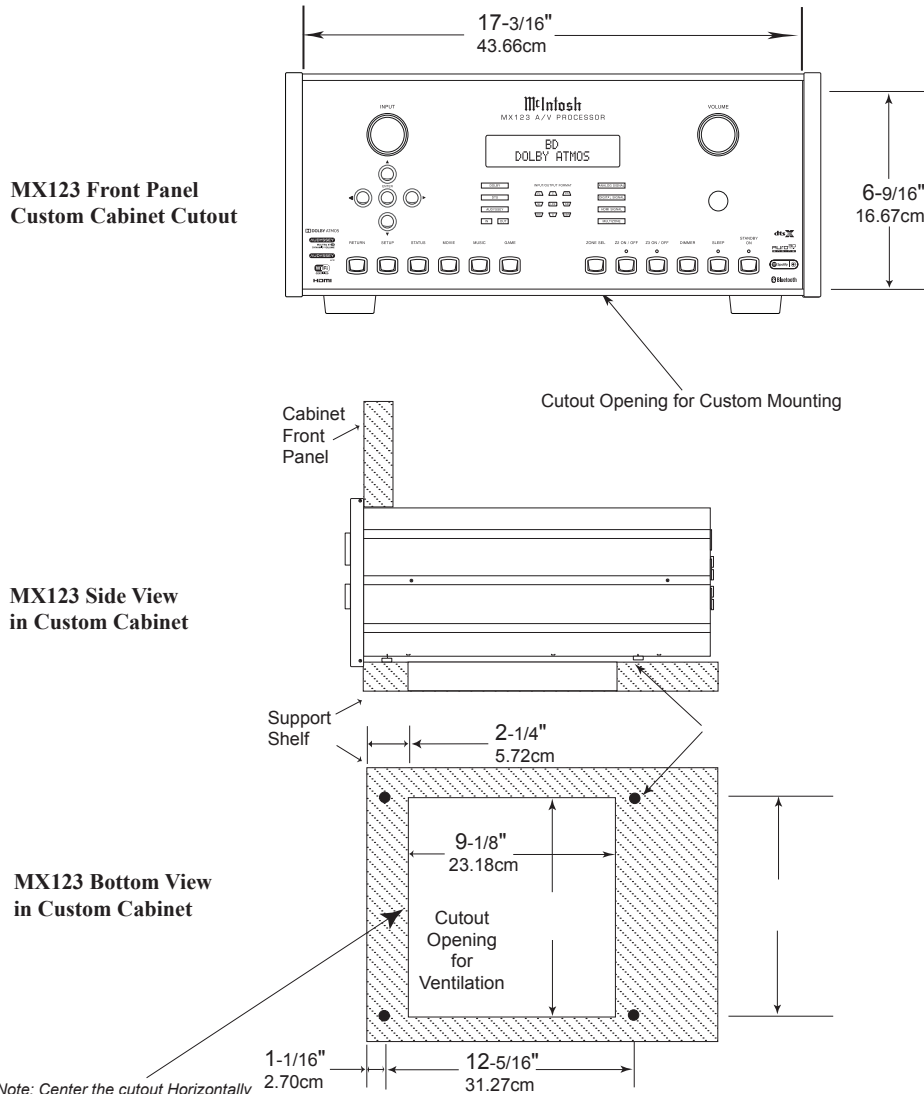

Figure 02– Custom cutout dimensions

## Securing the MX123 to a Shelf

A hardware package containing two “L” brackets and two screws along with four washers can be used to secure the MX123 to a shelf.

To secure the MX123 to a shelf using the supplied “L” brackets:

- Remove the two screws from the two lower corners on the back of the MX123. See Figure 03.
- Attach the longer portion of the “L” bracket to the rear of the MX123 using the same screw just removed from the rear of the MX123 and a supplied washer. Repeat for the other side. Never use different size screws. The “L” bracket should form a 90 degree angle with the lower portion facing away from the rear of the unit and resting on the shelf.
- Use the supplied screws and washers to attach the lower portion of the “L” brackets to the shelf.

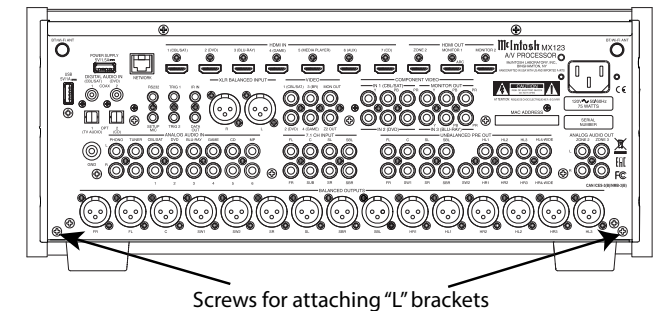

Figure 03– “L” bracket screws

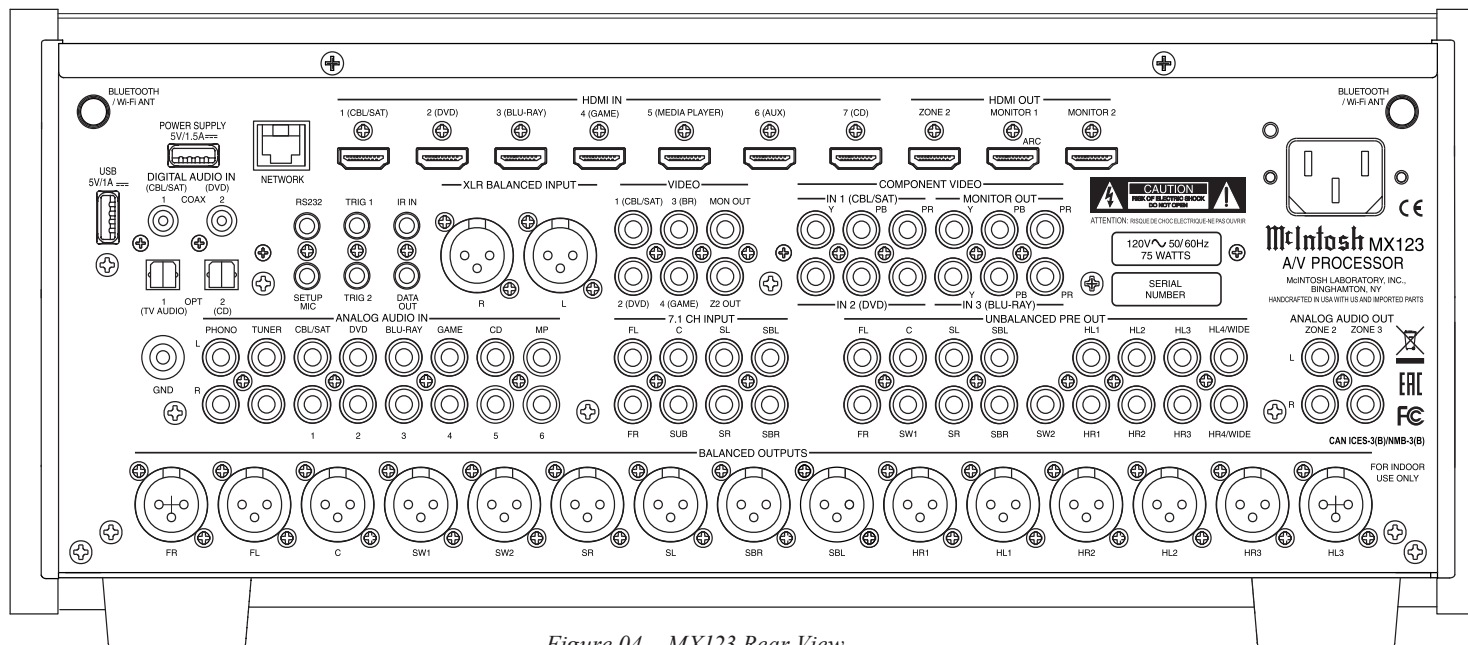

Figure 04– MX123 Rear View

## Connections on the Back

The MX123 has a wealth of connections. They can be divided into Inputs and Outputs.

### The Inputs

- Seven HDMI Inputs
- One pair balanced XLR Inputs (AES/EBU)
- Eight pairs RCA analog stereo Inputs including one MM (moving magnet) RCA stereo pair and ground connection
- Two coaxial digital audio Inputs
- Two Toslink optical Inputs
- Four RCA video Inputs
- Three sets of three component video RCA jacks
- One 7.1 CH Input with eight analog RCA jacks

- One USB port to supply power
- One USB port to connect storage
- One 10baseT LAN connector
- One 1/8 inch jack for microphone Input
- One 1/8 inch jack for RS232 connector
- One 1/8 inch jack for wired IR Input
- One AC power connector

### The Outputs

- 15 balanced XLR audio Outputs
- 17 unbalanced RCA Outputs
- Two 1/8 inch jack Power Control (trigger) Outputs
- Two RCA stereo pairs Output to two additional zones
- One set of three component video RCA Outputs
- Two RCA video Outputs
- One 1/8 inch Data Output jack

## Making Connections

### Bluetooth/Wi-Fi Antenna

Attach the two Bluetooth/Wi-Fi antennas that are included in the MX123 accessory package. Each antenna screws into a connector labeled BLUETOOTH/WI-FI ANT located in the top right and left corners of the rear panel. After attaching the antennas, point them upward.

### 10baseT LAN

Use an Ethernet cable to connect the MX123 to a network router. The network connector is located on the top left rear of the MX123. It is labeled NETWORK. By default, the MX123 has DHCP set to ON and will automatically receive an IP address from the router. This setting can be changed. (See “Network” on page 24.)



## HDMI

The MX123 has 7 HDMI Inputs. A high-performance HDMI cable is recommended to take advantage of the 18 Gbps speed capabilities of all 7 HDMI Inputs. The HDMI cables should support 4K@60Hz, HDR and YCbCr 4:2:2 (4:4:4/RGB) as well as Ethernet and ARC. Cables designed for HDMI 2.0 are fine. Though, HDMI is backward compatible, older cables may have issues with the higher bandwidth.

Use HDMI OUT MONITOR 1 when connecting to an ARC (Audio Return Channel) enabled television. ARC can provide two-way communication between units allowing for volume control and lip-syncing functions to ensure audio and video are perfectly matched. This allows for more intelligent operation between components as well as less cable clutter. Make sure the ARC is enabled in your TV's setup menu.

## USB

There are two type-A ports on the rear of the MX123. The port labeled POWER SUPPLY is used to supply power (5 volts / 1.5 amps) via a USB cable. The second port, labeled USB, is for USB memory devices. Use this second port for accessing music from USB storage devices. Plug the USB memory device directly into the port. USB hubs will not work. Because of the vast array of USB memory devices available from countless manufacturers, McIntosh does not guarantee that all USB memory devices will operate or receive power.

## Microphone

The microphone Input is for connecting the supplied MX123 Microphone using the microphone's attached cable and an 1/8 inch connector. The microphone is used in the Audyssey® calibration for

tuning the system to your room. For instructions see "Audyssey®" on page 28.

## RS232

The RS232 jack is used to connect the MX123 to automation controller devices with RS232 connectors. To utilize this feature, you will need an appropriate RS232 Data Cable. The RS232 Data Cable should be an 1/8 inch (3.5mm) stereo mini phone plug to a subminiature DB9 connector.

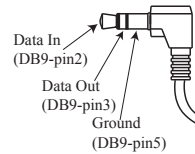

Figure 05— Mini plug for RS232 connection

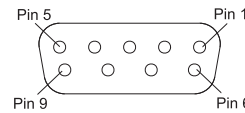

Figure 06— DB9 connector pin layout

### RS232 DB9 Connector Pin Layout

- |                        |        |
|------------------------|--------|
| 1. N/C (no connection) | 6. N/C |
| 2. Data In (RXD)       | 7. N/C |
| 3. Data Out (TXD)      | 8. N/C |
| 4. N/C                 | 9. N/C |
| 5. Gnd                 |        |

Typical RS232 settings are:

- 8 data bits, no parity and one stop bit
- Baud rate fixed at 115,200 bits per second

## Wired IR Inputs

The IR Input allows an external IR receiver to be attached to the MX123. The Input is labeled IR IN. By attaching an IR receiver using a 3.5mm cable

(See Figure 07), the MX123's Remote Control can be used in another location without a line-of-sight to the MX123's front IR sensor. In this way, if ZONE 2 is another room, a Remote Control can be used to adjust the MX123.

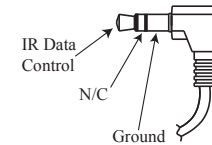

Figure 07— IR 3.5mm connector

If using an external IR receiver for the MAIN ZONE in the same room as the MX123, you may wish to **disable the front IR sensor**, which also controls the MAIN ZONE. This will avoid potential timing issues of receiving the Remote Control's commands from two different Inputs. The front IR can be turned on/off by doing the following:

- Put the MX123 in STANDBY mode
- While pressing and holding the front panel ENTER and RETURN buttons, press the STANDBY button (a 3-button push)
- Use the Down ▼ Arrow on the Front Panel or Remote Control to navigate to the RC LOCK Off option to enable the front panel IR sensor or choose RC LOCK On to disable the front panel IR sensor. See Figure 08
- Pushing ENTER will make the selection and reboot the MX123



Figure 08— Setting the Remote Control Lock



## Digital Inputs

There are four digital Inputs in the MX123:

- Two Toslink Optical Inputs
- Two Coaxial Digital audio Inputs

The two Coaxial Inputs are labeled:

- 1 (CBL/SAT)
- 2 (DVD)

The two Optical Inputs are labeled:

- 1 (TV AUDIO)
- 2 (CD)

The default names and assignments can be changed in setup.

The Optical Inputs require a Digital Optical Audio Cable Toslink Cable. The Coaxial Inputs use Digital Audio Coaxial Cables with male RCA type connectors.

## Analog Audio Inputs

There are eight pairs of gold-plated RCA jacks. The left jack of the stereo pair is on top, and the right jack is below it. They are labeled as follows:

1. PHONO
2. TUNER
3. CBL/SAT
4. DVD
5. BLU-RAY
6. GAME
7. CD
8. MP

To the left of the PHONO jacks is a ground connection labeled GND for connecting a turntable's ground wire. The PHONO section of the MX123 is designed to work with Moving Magnet cartridges.

There is one pair of Balanced XLR Inputs. It is

labeled XLR BALANCED Input. Looking at the back of the unit, the Right Input is on the left and the Left Input is on the right.

There are eight gold plated RCA jacks designed for 7.1 Channel Input. They are located under the heading 7.1 CH Input. They are labeled:

- FL (Front Left)
- FR (Front Right)
- C (Center)
- SUB (Subwoofer)
- SL (Surround Left)
- SR (Surround Right)
- SBL (Surround Back left)
- SBR (Surround Back Right)

All the Input names can be customized in the SETUP program, as well as hidden and restored. Hiding Inputs spares you from scrolling through unused Inputs.

## AC Power

This connection is essential. Plug the female end of the supplied AC Power Cord into the AC connector located in the rear right corner of the MX123. Plug the male end of the AC Power Cord into a grounded and functioning AC outlet.

## Balanced Audio Outputs

There are 15 male balanced XLR connections on the back of the MX123 to accommodate a wide variety of speaker configurations. Connect balanced XLR cables to the corresponding powered speakers or amplifiers. Here are the possible connections:

- FL (Front Left)
- FR (Front Right)
- C (Center)
- SW1 (Subwoofer 1)

- SW2 (Subwoofer 2)
- SR (Surround Right)
- SL (Surround Left)
- SBR (Surround Back Right)
- SBL (Surround Back left)
- HR1 (Height Right 1)
- HL1 (Height Left 1)
- HR2 (Height Right 2)
- HL2 (Height Left 2)
- HR3 (Height Right 3)
- HL3 (Height Left 3)

This is all easier said than done. Setting up speakers for a surround setup takes planning, measuring and installation. Depending on your level of expertise and available time, you may wish to employ the services of your McIntosh dealer for expert setup of your system. Professional installation of in-ceiling speakers is particularly important due to gravity and the location above your head.

The number, types and locations of speakers are key elements in setting up the system. There is a multitude of possible configurations, and the MX123 is very flexible in its setup to adapt to many of these configurations.

Often surround setups are referred to by numbers for example 7.1.4 or 9.1.2. The first number refers to the number of traditional surround speakers (front, center and surround). The second number is the number of subwoofers that can be connected, and the third number refers to the number of in-ceiling or upward firing speakers in the setup.

The type of speaker (size and location) will be entered later during Speaker setup. The distance of the speaker from the listening location will be entered in the Audyssey® setup. Make note of this information.

At this stage, the connection from the MX123 to the various amplifiers and powered speakers should be made using quality balanced XLR cables.

## Power Control (Trigger) Outputs

The MX123 has two Power Control Outputs or Triggers. Power Control enables power on/off signals to go to connected components so that other components can automatically power on (or off) as called for by the MX123. For example, you may want a DVD player and a certain monitor to power on when HDMI 1 Input is selected, or you may want all components to power off when powering off the MX123. For Setup instructions see “General Setup” on page 24.

Connect components using a 3.5mm stereo mini plug. See Figure 09.

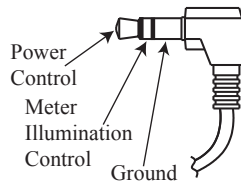

Figure 09– Power control (trigger) mini plug

## Analog Audio Output

Two additional Zones labeled ZONE2 and ZONE3 can be fed analog signals using a pair of RCA cables for each Zone. The jacks are located under ANALOG AUDIO OUT on the right side of the rear of the MX123.

## Data Out

The MX123 will convert IR Remote Control data to share with McIntosh components connected to the Data Ports. This will allow units that are out of range of an IR signal to receive commands.

To connect a McIntosh unit to a Data Port, use a 3.5mm stereo mini phone plug cable. See Figure 10.

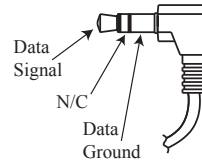

Figure 10– Power control (trigger) mini plug

## Setup Assistant

When the MX123 A/V Processor is initially powered on (or after a Factory Reset- see page 31), the Setup assistant will appear on the Display and a connected monitor. After choosing a language, follow the guide’s instructions to setup your Bluetooth/Wi-Fi Antenna Connection as well as Network Setup. For more information on Network Setup see “Network” on page 24.

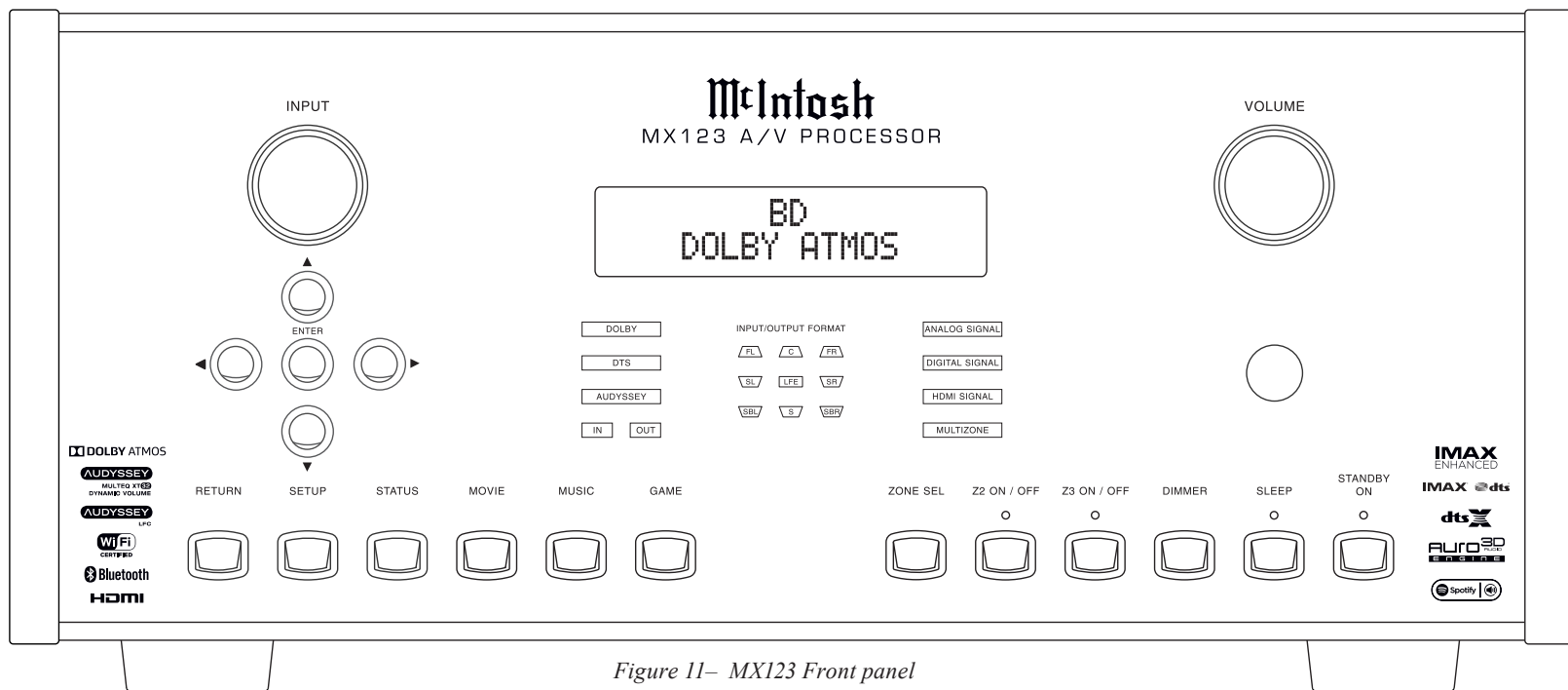

Figure 11- MX123 Front panel

## The Front Panel

The iconic front glass panel of the MX123 provides knobs and buttons to control the unit as well as an informational display and LED status lights that display the current mode.

### Standby On

The red STANDBY ON button toggles the MX123 between on and standby mode. The STANDBY button will only work with AC Power connected (see “AC Power” on page 10). When the unit is in standby mode, it can also be toggled on/off using the Remote Control or the browser interface. If Zone2 or 3 is on, those Zones will continue to be on. Those Zones can be toggled on and off using the

ZONE ON / OFF buttons. See “Zone On/Off” on page 13.

### The Input Knob

The Input Knob can be turned clockwise or counterclockwise to scroll through all the Inputs that are enabled in Setup. All Inputs are available by default.

### The Volume Knob

Turn this knob clockwise to raise the volume and go the other way to make it quieter. A maximum volume of 70% is the factory default for each zone. The value of the Volume Limit can be set in the General Setup section for each Zone. Options are 60, 70, or 80 percent. You can defeat the Volume

limit by choosing the “Off” option. A maximum volume prevents the MX123 from accidentally sending higher signals than your situation permits.

### The Arrow and Enter Buttons

These buttons are used to navigate menu screens and selections in the Trim menus. The arrows allow scrolling up ▲, down ▼, left ◀, and right ▶ when those are menu choices. The ENTER button accepts an option and the left ◀ button returns to the previous menu when a value is not being selected. If a value needs to be selected, the left ◀ and right ▶ arrows will scroll through the options. Push ENTER to select the chosen value.

## Status

Repeated presses of the Front Panel or Remote Control STATUS Push-button will step through the type of incoming Audio Signal, the selected Input (along with type of A/V Connection) and audio processing mode.

## Sound Mode Buttons

There are three buttons on the front panel that give you quick access to a selected sound/surround mode. The buttons are:

- MOVIE
- MUSIC
- GAME

These buttons can also be accessed from the Remote Control with the added choice of PURE.

The following choices are available when selecting the MOVIE, MUSIC and GAME buttons:

- Stereo
- Dolby Audio – Dolby Surround
- DTS Neural:X
- Auro-3D
- Auro-2D Surround
- Multi Ch Stereo

Choosing a button will switch to the last mode selected. The mode can be switched using the up ▲, and down ▼ arrows.

The PURE button on the remote offers the following modes:

- Direct- This mode plays back audio as recorded in the source
- Pure Direct- This mode plays back an even higher quality sound than the “Direct” mode. In order to further improve sound quality, the display indicator circuit of the main body

will be disabled (display will go off), and the analog video Input/Output switcher and processor is disabled

- Auto- In this mode, the type of digital signal Input, such as Dolby Digital, Dolby TrueHD, Dolby Digital Plus, Dolby Digital EX, Dolby Atmos, DTS, DTS-HD, DTS:X, DTS-ES, or PCM (multi-channel) is detected, and the playback mode switches automatically to the corresponding mode. If the Input signal is analog or PCM (2-channel), stereo playback is used. For Dolby Digital or DTS, the music is played back according to the respective channel number

The display screen, if on, will leave the Sound Mode screen after 5 seconds.

## Zone Select

The ZONE SEL button allows you to adjust the volume and input of Zone2 and Zone3 using the front panel knobs. Pressing the ZONE SEL button will toggle between Zone2 and Zone3. Stop at the Zone in which you wish to change the volume. After 5 seconds of not adjusting the volume for the chosen zone, the VOLUME knob will default to Main Zone.

## Zone On/Off

The MX123 has three Zones. Zone1 is called the Main Zone and is the default for the display. Analog stereo signals can be sent to Zone2 and Zone3. The Z2 ON / OFF and Z3 ON / OFF buttons toggle these zones on and off.

If you push the STANDBY ON button to power off the unit, Zone2 and/or Zone3 will remain on if they are currently on. To shut off these zones, use their respective Z2 ON / OFF or Z3 ON / OFF buttons.

These buttons can be used to turn on the desired zone if the MX123 is in standby mode.

If the Main Zone is off and one or both of the other Zones are on, this information will appear on the display.

## Dimmer

Pressing the DIMMER button cycles through 4 levels of Display brightness:

- Bright (Default): Normal display brightness
- Dim: Reduced display brightness
- Dark: Very low display brightness
- Off: Turns the display off

## Sleep Timer

The SLEEP button allows you to set a sleep timer between 10 minutes and 120 minutes for the Main Zone. Pressing the button will set the timer in 10 minute increments to the maximum or set the Sleep Timer to off. When a Sleep Timer is set for the Main Zone, the red LED above the SLEEP button will illuminate.

When the MX123 goes to sleep, the Zone2 and Zone3 will remain on. To set a Sleep Timer for these zones, use the SLEEP button on the Remote Control. Set the Remote Control to the desired zone using the ZONE SELECT button. The Remote Control’s SLEEP button will function the same as the front panel’s SLEEP button. Each Zone can have a separate sleep timer set.

## Changing GUI Language/Video Format

By holding both the STATUS button and the ZONE SEL button simultaneously for three seconds, the following setup option can be changed using the Arrow Buttons:



Setting	Options
Use up ▲ and down ▼ to select	Use left ◀ and right ▶ to select
GUI	English, French or Spanish
Video Format	NTSC or PAL
4K Format	Standard or Enhanced

## LED Channel Status Indicators

The yellow LEDs, in the center of the MX123 front panel, provide a visual display of the status of the main zone's signal for either Input or Output.

The Left Column Displays:

- DOLBY
- DTS
- AUDYSSEY
- IN OUT

Either IN or OUT will be lit depending on what has been chosen in Setup for the Front Display setting. (See Front Display under General Setup on page 25.) Other features will be lit if currently enabled for the current Input.

The middle section shows speaker channels that are active. Here are the channel abbreviations used:

- FL- Front Left
- C- Center
- FR- Front Right
- SL- Surround Left
- LFE- Low Frequency Effects
- SR- Surround Right
- SBL- Surround Back Left
- S- Surround (RS + LS)
- SBR- Surround Back Right

Channels currently used will be lit.

The right display has the following information:

- ANALOG SIGNAL

- DIGITALSIGNAL
- HDMI SIGNAL
- MULTIZONE

The Main Zone's signal type will be lit. If Zone2 and/or 3 is active, the MULTIZONE will light.

Pushing the INFO button on the MX123 Remote Control will show the following information on an attached monitor:

- SOURCE
- SOUND
- SIGNAL
- INPUT SIGNAL (CHANNELS)
- ACTIVE SPEAKERS

The indicators for Input SIGNAL include the speaker channels listed above plus:

- FHL- Front Height Left
- FHR- Front Height Right
- FWL- Front Wide Left
- FWR- Front Wide Right
- EXT- extension channel

The extension channel will light when a channel other than the listed ones is part of the Input.

## Setup

Pushing the SETUP button will bring up the Setup Menu on an attached monitor. When in setup mode, the Display will show the current level and option (See Figure 12). You can navigate using the Display, but an attached monitor is easier.

To exit setup mode, push the SETUP button again.



Figure 12– Display in Setup Mode

## The Setup Menu

The factory default settings will allow you to use the MX123 as soon as you properly connect your components. However, sooner or later, you may wish to fine tune your system. You can utilize the MX123's robust setup program for customization and optimization of your Audio Visual environment. MX123 setup can be performed by using either the SETUP button on the Front Panel or the Remote Control and using an attached monitor (local setup), or through a web browser on a computer if the MX123 is connected to your network. See Figure 13.

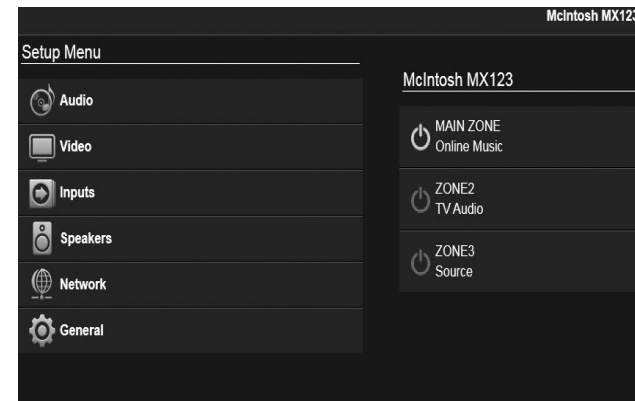

Figure 13– Browser Setup Menu

The procedures and screens are essentially the same for all methods. The availability of a mouse and a keyboard in the browser method may be easier to navigate than using the arrow buttons on the Front Panel or Remote Control that are used for local setup. You can choose to use the Front Panel Display to navigate setup, but the limited screen size would make this the least desirable setup method.

To use a browser to navigate setup, type the IP address for the MX123 in the address bar of your browser. You can find the IP address under the Information submenu under the Network section of

setup (see “Network” on page 24).

Setup has the following sub-menus:

- Audio
- Video
- Inputs
- Speakers
- Network
- General

In this manual, sub menus are denoted in the style “**Setup Menu>General>Front Display>Dimmer**” which means from the “SETUP Menu” choose “General” and then choose “Front Display” and then “Dimmer”.

## Browser Security Warning

When you attempt to load the Setup Menu on a browser, you will likely see some version of a Warning that you are about to experience a Potential Security Risk or some computer attack. Do not worry about this scary warning generated from your browser. It is a result of the MX123 using the more secure HTTPS connection and the browser is not recognizing the local certificate. The connection is actually more secure than past software interfaces by using this secure connection. To use this more secure connection, you must first proceed using your browser’s Advanced setting options. Choose the advanced option or “continue anyway” option to proceed to the Setup Menu page against all your browser’s warnings. The advanced options will be slightly different depending on your browser, but all of them will allow the choice to continue the Setup Menu page. After initially bypassing this screen, your browser should open this page in the future without hesitation.



### Your connection is not private

Attackers might be trying to steal your information from **192.168.1.110** (for example, passwords, messages, or credit cards). [Learn more](#)

NET:ERR\_CERT\_AUTHORITY\_INVALID

Help improve Safe Browsing by sending some [system information and page content](#) to Google. [Privacy policy](#)

Advanced

Back to safety

Figure 14– Sample Browser Warning screen

## Speakers- Setup Menu

The Speakers Setup menu has two main parts:

- Audyssey®
- Manual Setup

Audyssey® Setup is detailed starting with “Audyssey® Setup” on page 28. Audyssey® will provide much of the information that can be set in the Manual Setup portion. The Manual Setup allows you to tell the MX123 what your speaker setup and preferences are. We will begin by covering the Manual Setup.

## Amp Assign

### Setup Menu>Speakers>Manual Setup>Amp Assign

In Amp Assign, you select how to use the preamplifier section of the MX123. In the Amp Assign section of Setup, you can tell the MX123 what speaker setup scheme you will be using. This affects what speaker types are available in the Manual Setup for speakers explained in the next section.

The default setting is 13.1 channels which will provide great flexibility in the speaker setup. Some

available options are dependent on other setup choices. Here are all the available setup options for Amp Assign:

Setting	Options
Use up ▲ down ▼ to select	Use left ◀ and right ▶ to select
Layout	13.1 channel 11.1 channel (Bi-Amp) 11.1 channel + Front B Pre-out for Bi-Amp and Front B options: <ul style="list-style-type: none"> <li>• Surround Back</li> <li>• Height 2</li> <li>• Height 3</li> </ul>
Floor -Layout	5 channel 5 channel & FW 5 channel & SB
Height Sp	None 2 channel 4 channel 5 channel 6 channel 7 channel 8 channel
Dolby Sp	None 2 channel 4 channel
Height -Layout	Front Dolby Surround Dolby Back Dolby
Height -Front Layout	Front Height Front & Center Height
Height -Middle Layout	Top Surround Surr. Height & Top Surround



Setting	Options
Use up ▲ down ▼ to select	Use left ◀ and right ▶ to select
Height -Rear Layout	Top Rear Rear Height Surround Height Top Middle Top Rear

## Speaker Types and Positions

The following table and diagrams show possibilities for speaker setup as well as the terms used to describe them.

You will need the number and types of speakers as well as the distance of each from the main listening position for the Speaker Configuration in Setup.

FL/FR (Front speaker Left/Right)	FRONT Left and Right speakers should be an equal distance from the main listening position. The distance between each speaker and your TV should also be about the same.
C (Center)	The CENTER speaker should be between the Front speakers and above or below your TV.
SL/SR (Surround speaker Left/Right)	The SURROUND Left and Right speakers should be an equal distance from the left and right sides of the main listening position. If you don't have Surround Back speakers, move the surround speakers slightly behind your listening position.

FWL/FWR (Front Wide speaker Left/Right)	The FRONT WIDE Left and Right speakers should be outside of the front Left and Right speakers so that there is an equal distance between all Front speakers.
SBL/SBR (Surround Back Left/Right)	Place the SURROUND BACK Left and Right speakers an equal distance from the main listening position and directly behind the main listening position. When using a single Surround Back speaker (SB), place it directly behind the listening position.
SW 1/2 (Subwoofer)	Place the SUBWOOFER at a convenient location near the Front speakers. If you have two Subwoofers, place them asymmetrically across the front of your room.
FDL/FDR (Front Dolby speaker Left/Right)	Place the FRONT Dolby Atmos Enabled speaker on the Front speaker. For a Dolby Atmos Enabled integrated with a Front speaker, place the Dolby Atmos Enabled speaker instead of the Front speaker.
SDL/SDR (Surround Dolby speaker Left/Right)	Place the SURROUND Dolby Atmos Enabled speaker on the Surround speaker. For a Dolby Atmos Enabled speaker integrated with a Surround speaker, place the Dolby Atmos Enabled speaker instead of the Surround speaker.

BDL/BDR (Back Dolby speaker Left/Right)	Place the BACK Dolby Atmos Enabled speaker on the surround back speaker. For a Dolby Atmos Enabled speaker integrated with a Surround Back speaker, place the Dolby Atmos Enabled speaker instead of the Surround Back speaker.
FHL/FHR (Front Height speaker Left/Right)	FRONT HEIGHT Left and Right speakers are mounted directly above the Front speakers. Mount them as close to the ceiling as possible and aim them towards the main listening position.
TFL/TFR (Top Front speaker Left/Right)	Mount the TOP FRONT Left and Right speakers on the ceiling slightly in front of your main listening position and align with the Left and Right Front speakers.
TML/TMR (Top Middle speaker Left/Right)	Mount the TOP MIDDLE Left and Right speakers directly above the main listening position and align with the Left and Right Front speakers.
TRL/TRR (Top Rear speaker Left/Right)	Mount the TOP REAR Left and Right speakers on the ceiling slightly behind your main listening position and align with the Left and Right Front speakers.
RHL/RHR (Rear Height speaker Left/Right)	Place the REAR HEIGHT Left and Right speakers directly behind the main listening position. Mount them as close to the ceiling as possible and align with the Left and Right Front speakers.



SHL/SHR (Surround Height speaker Left/Right)	Place the SURROUND HEIGHT Left and Right speakers directly above the Surround speakers.
CH (Center Height speaker)	Place the CENTER HEIGHT speaker directly above the Center speaker. Mount it as close to the ceiling as possible and aim it towards the main listening position.
TS (Top Surround speaker)	Place the TOP SURROUND speaker directly above the main listening position and align with the Center channel speaker.

Note that the Amp Assign default setting of 13.1 is recommended for 5.1, 7.1, 9.1 and of course 13.1 playback. 11.1 channel playback should be used for 11.1 channel Bi-amp and 11.1 channel second pair of front speakers playback.

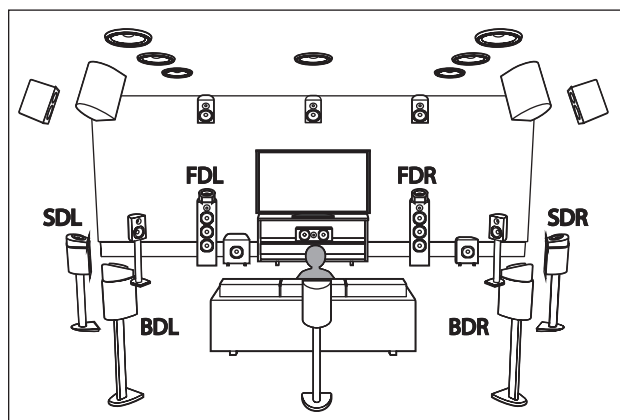

Figure 15– Speaker Positions and abbreviations

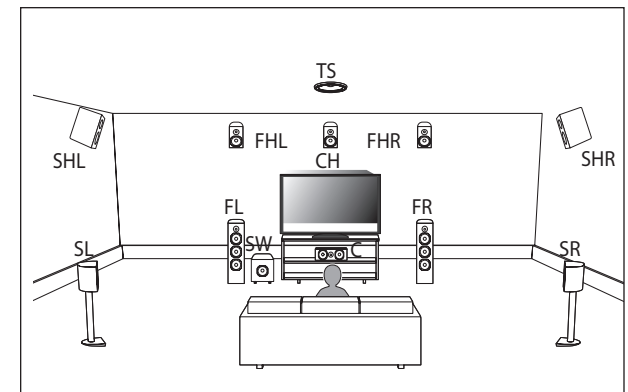
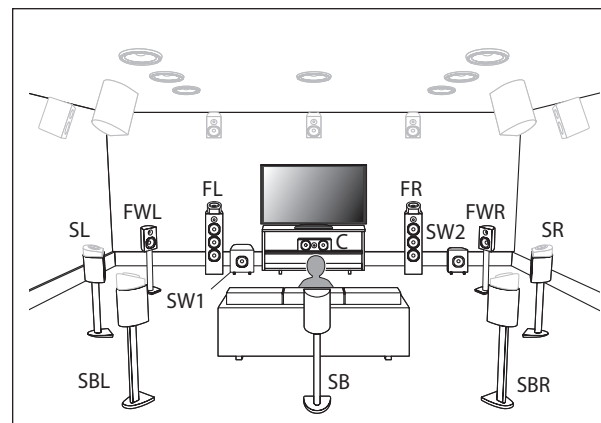
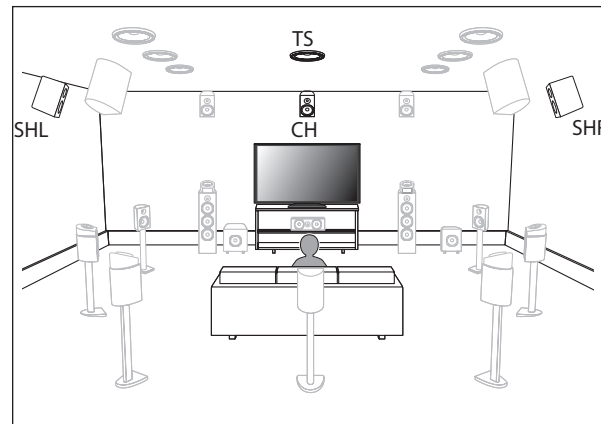
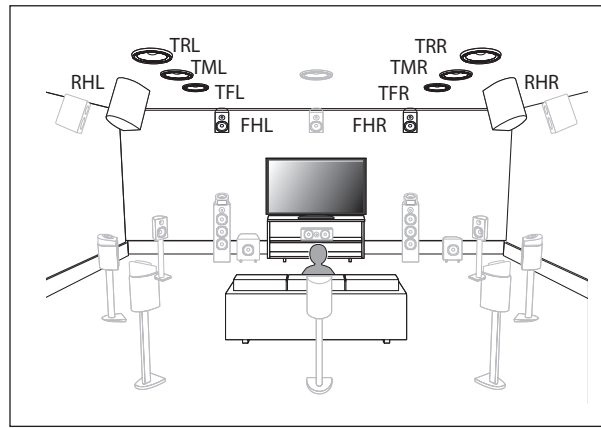

Figure 16– Auro-3D layout example

The above example is a combination of 5.1 channel speakers with Front Height/Surround Height/Center Height/Top Surround speakers.

For the best Auro-3D experience Surround Height speakers are recommended, however you may substitute Rear Height speakers from a Dolby Atmos speaker setup in place of Surround Height speakers.

You will need at least Front Heights for Auro-3D to be an option.

## Speaker Configuration

### Setup Menu>Speakers>Manual Setup>Speaker Config

Here is where you tell the MX123 what type of speakers are connected. The available speaker categories are based on the settings in Amp Assign (See “Speakers- Setup Menu” on page 15).

Speakers are defined as Large or Small (or None). A Large Speaker is a full-range speaker. (Technically, a speaker able to reproduce bass frequencies down to 35Hz within -3dB of the midrange frequencies.) If it is not Large, then it is Small. If it doesn't exist, choose None.

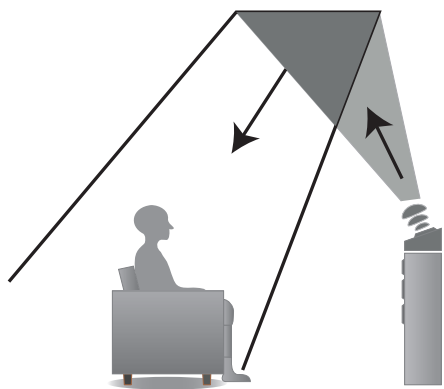

Figure 17– Dolby Atmos Enabled speakers

Dolby Atmos Enabled speakers reflect the sound off the ceiling to allow the sound to come from over your head by using a special upward-pointing speaker that is placed on the floor. See Figure 17. You can enjoy the Dolby Atmos 3D sound even in an environment where speakers cannot be installed on the ceiling.

Speaker	Options
Front	Large / Small
Center	Large / Small / None
Subwoofer	None/ 1 spkr / 2 spkrs
Surround	Large / Small / None
Surr. Back	Large / Small / None 1 spkr / 2 spkrs
Front Wide	Large / Small / None
Front Height	Large / Small / None
Rear Height	Large / Small / None
Center Height	Large / Small / None
Top Surround	Large / Small / None

## Speaker Distances

### Setup Menu>Speakers>Manual Setup>Distances

In this section, the distances of the speakers from the main listening position should be entered. This will aid in perfecting 3D imaging. A laser pointer may be a helpful tool to measure the distance from a speaker to the main listening position.

In the Distances submenu, there are two menu settings, Unit and Step, that each have two options. For Unit, you can choose Feet or Meters as the unit of measurement.

Step sets the value of each button push for setting the distances. The Step values are 0.1 or 1. You can use the larger Step value to Input the rough measurements and then the smaller Step value to fine tune. This may save you many button pushes.

## Speaker Levels

### Setup Menu>Speakers>Manual Setup>Levels

Selecting Levels allows you to make changes to the Output levels of each speaker –12.0dB to +12.0dB. These set levels are reflected in all sound modes.

Select Test Tone Start. You will then be able to play a Test Tone on all available speakers and adjust the relative Output levels.

You can choose Set Defaults on the Test Tone Start screen to set all levels to factory defaults (0.0dB).

## Crossovers

### Setup Menu>Speakers>Manual Setup>Crossovers

Crossovers can be set when the “Subwoofer Mode”

setting is “LFE+Main”, or when you have a speaker that is set to “Small”.

The default crossover frequency is “80Hz”, which will work best with the widest variety of speakers. We recommend setting to a higher frequency when small speakers are used. For example, set to “250Hz” when the frequency range of the speakers is 250Hz to 20kHz.

Sound below the crossover frequency is cut off from the Output to “Small” speakers and is outputted to the subwoofer or front speakers.

You can choose Individual or All. The Individual option will allow each available speaker’s crossover frequency to be set individually. The All option will globally set the Crossover Frequency to the chosen value. Available values are:

40 Hz / 60 Hz / 80 Hz / 90 Hz / 100 Hz /  
110Hz / 120 Hz / 150 Hz /200 Hz / 250 Hz

## Bass

### Setup Menu>Speakers>Manual Setup>Bass

The Subwoofer Mode can be set for:

- LFE (Low Frequency Effects) which would provide only the LFE channel
- LFE+Main which would include the Main channel as well as the LFE channel

LPF for LFE allows the LPF (Low Pass Filter) setting for the Subwoofer Mode to be changed. The options are:

80 Hz / 90 Hz / 100 Hz / 110 Hz / 120 Hz /  
150 Hz /200 Hz / 250 Hz

## Front Speaker

### Setup Menu>Speakers>Manual Setup>Front Speaker

If Amp Assign is set to the Front B option, the Front Speaker setting will be available. See Layout under Amp Assign on page 15.

Options for the Front Speaker setting are: A / B / A+B.

## 2 Channel Playback

### Setup Menu>Speakers>Manual Setup>2ch Playback

2 Channel Playback can be set automatically or manually. Here are the setup options:

2ch Setting	Options
Setting	Manual / Automatic
Front	Small / Large
Subwoofer	Yes / No
SW (Subwoofer) Mode	LFE / LFE+Main
Crossover	40/60/80/90/100/110/ 120/150/200/250 Hz
Distance FL	0 feet to 32 feet 0 meters to 9.6 meters
Distance FR	0 feet to 32 feet 0 meters to 9.6 meters
Level FL	-12 dB to +12 dB
Level FR	-12 dB to +12 dB

## Audio- Setup Menu

### Setup Menu>Audio

Depending on your speaker configuration and options, the following settings may be adjusted in the Audio Setup section:

- Subwoofer Level Adjust
- Bass Sync
- DFR
- Audio Delay
- Volume
- Audyssey
- Graphic EQ

## Subwoofer Level Adjust

### Setup Menu>Audio>Subwoofer Level Adjust

This setting allows you to adjust the level of Subwoofer 1 and the level of Subwoofer 2 (if they exist) from -12dB to +12dB in .5dB increments.

## Bass Sync

### Setup Menu>Audio>Bass Sync

For contents recorded in multi-channel such as Blu-ray discs, the recorded Low Frequency Effects (LFE) may be out of sync and delayed. This function allows you to correct the delay with an adjustment of 0 ms to 16 ms.

## Sound Parameter

### Setup Menu>Audio>Sound Parameter

This allows Cinema EQ to be turned On or Off. Cinema EQ softens the treble range of a movie soundtrack using Dynamic Compression and Dialogue Normalization for better understanding of movie dialogue.

The Sound Parameter option is only available for the current sound mode if it applies. Settings are saved for each individual sound mode.

## DFR

### Setup Menu>Audio>DFR

DFR, which stands for Dynamic Frequency Restorer, restores compressed audio formats to near their original sound before compression. DFR will work on compressed audio formats such as MP3, WMA, and MPEG4 AAC. The options for the DFR setting are:

- OFF- DFR is disabled
- High- Optimized mode for compressed sources with very weak highs (64 kbps and under)
- Medium- Applies suitable bass and treble boost for compressed sources (96 kbps and under)
- Low- Optimized mode for compressed sources with normal highs (96 kbps and over)

## Audio Delay

### Setup Menu>Audio>Audio Delay

Audio Delay compensates for incorrect timing between video and audio. When Auto Lip Sync is set to On, the timing difference will be automatically corrected with compatible TVs. The Adjust option allows you to manually adjust the delay correction from the Default of 0 ms up to 500 ms.

## Volume Setup

### Setup Menu>Audio>Volume

There are four variables that can be changed in the Volume setup:

- Scale- There are two choices for how to display the Volume. The default is a scale of 0 to 98. The second option is to show the decibel (dB) level. The decibel scale is from -79.5dB to 18dB



- **Limit**-There are four options for setting a maximum allowable volume level- Off, 60 (-20dB), 70 (110dB), and 80 (0dB). Setting a Volume Limit can protect equipment and/or ears from unintended extreme volume
- **Power On Level**- You can set the Volume level which the MX123 will power on to. Choices are Mute, Last (last volume used) or any other available volume level from 1 (-79dB) to the maximum volume or the Volume Limit if one is set
- **Mute**- You can set what volume reduction occurs when the MUTE button on the Remote Control is pushed. Options are Full, -40dB and -20dB

## Audyssey® Options Menu

### Setup Menu>Audio>Audyssey®

After Audyssey® Setup (“Audyssey® Setup” on page 28 ) has been performed, the following setup options may be available:

- MultEQ XT32
- Dynamic EQ
- Audyssey® LFC

**MultEQ XT32** optimizes the frequency response of your speakers. It compensates for both time and frequency characteristics of the listening area based on Audyssey® Setup. The default setting is Reference. Reference provides a compensation curve that is optimized for movies with a slight roll off at the higher frequencies. The Flat setting is optimized for small rooms where your listening position is closer to the speakers. Keep in mind that many movie soundtracks are optimized for large theaters. The options in the Audyssey® setup section help maintain the theater experience in smaller

spaces as well as at lower volumes. The third MultEQ XT32 choice is Off which will turn off the MultEQ XT32 equalization.

**Dynamic EQ** solves the problem of deteriorating sound quality as volume is decreased by taking into account human perception and room acoustics. Dynamic EQ can be turned On and Off. If it is On (the default), the Reference Level Offset option appears. Audyssey® Dynamic EQ® is referenced to the standard film mix level. It makes adjustments to maintain the reference response and surround envelopment when the volume is turned down from 0dB. However, film reference level is not always used in music or other non-film content. Dynamic EQ Reference Level Offset provides three offsets from the film level reference (5dB, 10dB, and 15dB) that can be selected when the mix level of the content is not within the standard.

Offset	Content
0dB	(Default) Optimized for movies
5dB	Select this setting for content that has a very wide dynamic range, such as classical music
10dB	Select this setting for jazz or other music that has a wider dynamic range. This setting should also be selected for TV content as that is usually mixed at 10dB below film reference
15dB	Select this setting for pop/rock music or other program material that is mixed at very high listening levels and has a compressed dynamic range

**Dynamic Volume** solves the problem of large variations in volume level between TV, movies and other content (between quiet passages and loud

passages, etc.) by automatically adjusting to the user’s preferred volume setting.

The settings available for Dynamic Volume ranging from least adjustment are: Off, Light, Medium and Heavy. Medium is the default set if Dynamic Volume is set to Yes in Audyssey® Setup.

**Audyssey® LFC™** cuts the excessive low frequencies that plague your neighbor, but without removing bass perception in the room where the home theater system is operating. This is accomplished by dynamically monitoring low frequencies and reducing the “offending” ones. Audyssey® LFC™ can be turned On and Off. If On, the Containment Amount may be set between 1 and 7. The default is 4. The higher the setting the greater the containment of low frequencies.

## Video- Setup Menu

### Setup Menu>Video

The Video Setup section has the following sub-menus:

- Picture Adjust
- HDMI Setup
- Output Settings
- Analog Video Out
- On Screen Display
- 4K Signal Format
- TV Format

## Picture Adjust

### Setup Menu>Video>Picture Adjust

**Picture Adjust** allows you to select a Picture Mode that best matches the video content to the viewing environment. Picture Mode options are:

- Off- No picture adjustment

- Standard- best choice for most living room environments
- Movie- best suited for watching movies in a darkened room (such as a theater room)
- Vivid- brightens images, suitable for gaming
- Streaming- designed for watching low bit video sources
- Custom- allows manual picture quality adjustments. Contrast, Brightness, and Saturation can be adjusted on a scale of -50 to +50. Video Noise Reduction can be changed from its default of Off to Low, Medium or High. Enhancer emphasizes picture contours and is set on a scale from a default of 0 to 12

## HDMI Setup

### Setup Menu>Video>HDMI Setup

**HDMI Setup** provides options for HDMI Audio Out, HDMI Pass Through and HDMI Control settings:

- **HDMI Audio Out** setting is available only when the HDMI Control is set to off. This setting channels the HDMI Audio Output HDMI to either AVP, which would be speakers controlled through the MX123, or TV which would use the TV's speakers
- **Vertical Stretch**- The ability to stretch the video signals vertically can be toggled On or Off
- **HDMI Pass Through** can be toggled On and Off. HDMI Pass Through transmits the selected HDMI Input through this unit's HDMI Output while the unit is in standby power mode. If HDMI Pass Through is On, a **Pass Through Source** can be selected. Source choices are the seven HDMI Inputs

listed under their assigned names. The default source is CBL/SAT. If you choose Last as the source, the last used HDMI source will be the one used in Standby mode. **RC Source Select** tells the MX123 how to respond, when in Standby Mode, to a Source command from the Remote Control. If the default Power On + Source option is selected, pressing a source button on the Remote Control will turn the MX123 on and select that Input source. With the Source Select Only option, the HDMI Input will change, but the MX123 will remain in Standby

- **HDMI Control** can be toggled On and Off to allow a connected CEC compatible TV connected to HDMI MONITOR 1 to send control functions over the HDMI cable. CEC (Consumer Electronics Control) is an addition to the HDMI standard which allows control signals from one device to communicate with another device via an HDMI cable connection. If you change HDMI Control settings, reset power to connected devices. Make sure CEC is enabled on all devices

The table below shows additional options for HDMI Control:

Options	HDMI Control On	HDMI Control Off
<b>ARC</b> (Audio Return Channel)	On	On/Off* (*Default)
<b>TV Audio Switching</b> - automatically select a TV Audio Input when receiving a command from the TV	On/Off	Not Available

Options	HDMI Control On	HDMI Control Off
<b>Power Off Control</b> - MX123 will enter Standby Mode when a connected TV is turned off regardless of Input source for All, and for HDMI, COMP and VIDEO Input sources with Video selected	All/Video/Off	Not Available
<b>Power Saving</b> - use Power Saving functions when enabled	On/Off	Not Available

## Output Settings

### Setup Menu>Video>Output Settings

In this section, adjustments can be made to the video Output.

## HDMI Video Output

### Setup Menu>Video>Output Settings> HDMI Video Output

**HDMI Video Output** selects the HDMI monitor to be used. Options are:

Auto (Dual)	The presence of a TV connected to the HDMI MONITOR 1 or HDMI MONITOR 2 connector is detected automatically, and that TV connection is used
Monitor 1	A TV connected to the HDMI MONITOR 1 connector is always used



Monitor 2	A TV connected to the HDMI MONITOR 2 connector is always used
-----------	---

## Video Mode

### Setup Menu>Video>Output Settings>Video Mode

**Video Mode** configures the processing method to match the type of video content. Options are:

Auto (Default)	Process video automatically based on the HDMI content information
Game	Always process video for game content. Minimize the video delay when the video is delayed compared to the button operations on the controller of the game console
Movie	Perform image processing that is suitable for contents other than games

If Video Mode is set to Auto, the mode is switched according to the Input contents.

## Video Conversion

### Setup Menu>Video>Output Settings>Video Conversion

Video Conversion enables the conversion of non-HDMI sources to the HDMI Output. Video signals will be converted to the proper monitor Output format.

Options are On and Off. Off will disable Video Conversion. If disabled, on-screen graphics, such as the volume bar, may not be displayed over the video

signal.

When Video Conversion is enabled (On), the following settings are available:

**i/p Scaler** sets the video Input signal to be subjected to i/p Scaler processing. i/p Scaler will convert the resolution of the Input video signal to the value set in Resolution (see Resolution below). i/p Scaler options are:

Analog	Use i/p (interlace-to-progressive) scaler function for analog video signals
Analog & HDMI	Use i/p Scaler function for analog and HDMI video signal
Off	Do not use i/p Scaler function

If i/p Scaler is enabled the following options for these settings will be available:

**Resolution** can be set to Auto which will automatically select the resolution based on the attached monitor's capabilities. The following resolutions can be manually selected: 480p/576p, 1080i, 720p, 1080p, 1080p:24Hz, 4K, and 4K (60/50). These settings can be set for analog resolution and HDMI resolution independently.

**Sharpness** can be turned On and Off. Off is the default. The video enhancer sharpness feature provides image edge contouring which is optimized for converting lower resolution standard definition video to 4K.

**Progressive Mode** sets an appropriate progressive conversion mode for the source video signal.

Options are:

Auto (Default)	The video signal is automatically detected and the appropriate mode is set
----------------	--

Video	Mode suitable for video playback
Video and Film	Mode suitable for video and 30-frame film material playback

**Aspect Ratio** can be set for the default 16:9 Output or 4:3 Output with black bars on the sides of a 16:9 screen (except for 480p/576p Output). Aspect Ratio is expressed in terms of width:height.

## Analog Video Out

### Setup Menu>Video>Video Out

Analog Video Out allows you to select which zone receives video and component video Output. Options are:

Component Video Output	Main Zone Zone2 Zone3
Video Output	Main Zone Zone3

## On Screen Display

### Setup Menu>Video>On Screen Display

On Screen Display preferences can be selected as follows:

Volume- display of volume level	Bottom (default) Top Off
Info- temporarily displays status of Input source when switched	On (default) Off
Now Playing- on-screen display for Online Music Source	Always on (default) Auto Off- show for 30 seconds

## 4K Signal Format

### Setup Menu>Video>4K Signal Format

There are two options for 4K playback to an HDMI 4K (60Hz/50Hz) device.

Standard (default)	Select if your TV and playback devices support standard 4K 60p 4:2:0 8 bit video signals
Enhanced	Select if your TV, playback devices, and cables support high quality 4K 60p 4:4:4, 4:2:2 or 4K 60p 4:2:0 10 bit video signals

Use of a premium high speed HDMI cable is recommended for Enhanced playback. Make sure the connected 4K device's settings are properly set.

## TV Format

### Setup Menu>Video>TV Format

There are two options for the video signal Output format to be sent to your TV:

- NTSC (Default)
- PAL

NTSC is the video standard used in North America and most of South America. PAL is commonly used in most of Western Europe, China, India, Australia, and most of Africa.

## Inputs Setup Menu

### Setup Menu>Inputs

The MX123 will work without making any changes to the Inputs. The following Input options can be customized:

- Input Assign
- Source Rename
- Hide Sources
- Source Level
- Input Select

## Input Assign

### Setup Menu>Inputs>Input Assign

Different Input Sources can be assigned to different Input connectors. The default assignments are as follows:

Input Source	Input Connector				
	HDMI	DIGITAL	ANALOG	COMP	VIDEO
CBL/SAT	1	COAX1	1	1	1
DVD	2	COAX2	2	2	2
Blu-ray	3	-	3	3	3
Game	4	-	4	-	4
Media Player	5	-	6	-	-
TV Audio	X	OPT1	-	-	-
AUX	6	-	-	-	-
CD	7	OPT2	5	-	-

Use the arrows to scroll up ▲, down ▼, left ◀, and right ▶ in the Input Assign table. On a cell you wish to change, press ENTER. Use the left ◀ and right ▶ arrows to scroll through available values. Press ENTER to make your choice.

Only available options will be choices. For example, only OPT1, OPT2, COAX1 and COAX2 are available for Digital Inputs. When an HDMI channel is selected, it will be removed from its previous assignment. Also, when HDMI Control or ARC is set to On in the menu, HDMI cannot be assigned to TV Audio.

## Source Rename

### Setup Menu>Inputs>Source Rename

All Input source's names can be customized. The new name will appear whenever that Input is displayed.

The Set Defaults button will return ALL names back to their original names.

## Hide Sources

### Setup Menu>Inputs>Hide Sources

You can hide any unused Input from being displayed. This will save you the trouble of scrolling through them. Select Hide for any Input you wish to hide. Selecting Show, which is the default, will make the Input visible once again.

## Source Level

### Setup Menu>Inputs>Source Level

Difference in Input volumes may be corrected with Source Level. Analog Inputs and Digital Inputs can each be adjust from -12dB to +12dB. The adjustment is saved for the currently selected Input source.

## Input Select

### Setup Menu>Inputs>Input Select

Input Select allows you to set the audio Input mode of each Input source. The Input modes available for selection may vary depending on the Input source.

Options for Input Mode are:

- Auto- this default mode is recommended for most circumstances. It will automatically detect an Input signal and perform playback accordingly
- HDMI- plays only HDMI signals
- Digital- plays only digital audio Input



- Analog- plays only analog audio Input
- 7.1CH IN- only plays signals from the 7.1CH Input connector

## Network

### Setup Menu>Network

The MX123 A/V Processor can be connected to your home network through a wired or wireless LAN connection. The Network section of Setup allows you to configure your network settings.

The Network menu has the following submenus:

- Information
- Connection
- Settings
- Network Control
- Friendly Name
- Diagnostics

**Information** displays the following information: Friendly Name, Connection, SSID, DHCP status, IP Address, MAC Address (Ethernet), MAC Address (Wi-Fi) as well as a graphic representing Wi-Fi signal strength.

**Connection** has two options: Wired (Ethernet) and Wireless (Wi-Fi). Wireless is the default. Choosing the Wi-Fi option will bring up a Wi-Fi Setup button. There will be four options for connecting to a Wi-Fi network:

- **Scan Networks-** select from a list of discovered networks. Choose Rescan to refresh the list. Choose a network, then enter the password and select OK
- **Use iOS Device-** if you have an Apple device (iPhone, iPod, iPad) running iOS 7 or later, launch the settings app on your device and select “Wi-Fi” and then choose “McIntosh MX123” under SET UP NEW AIRPLAY

SPEAKER. Follow your device’s instructions

- **WPS Router-** Press the WPS switch on your router. Press Connect on the WPS Router submenu screen within two minutes
- **Manual-** allows you to manually enter the SSID, Security encryption method and password for your wireless network. Select Connect when done

**Settings** configures the IP address of the MX123. The default setting is DHCP On. In most cases, the MX123 will receive the required information from the router.

If you switch DHCP to Off, you can manually enter the IP address information which is handy if you want to use a particular unchanging IP address. You will need the following information to manually set the IP address:

- IP address
- Subnet Mask address (Typically 255.255.255.0)
- Default Gateway address (Address of your router)
- DNS address

**Network Control** gives you the option of suspending the network function when the MX123 is in standby mode. This will conserve some power in standby mode, but the MX123 can not be woken from a network controller when Off In Standby is selected.

The default setting for Network Control is Always On. This allows the MX123 to be operable with a network compatible controller.

**Friendly Name** allows you to select what name will be displayed for the MX123 on your network. Options are: Home Theater / Living Room / Family Room / Guest Room / Kitchen / Dining Room / Master Bedroom / Bedroom / Den /Office / Other.

Choosing Other will allow you to Input a custom name.

**Diagnostics** will test the network connection and report any errors.

## General Setup

### Setup Menu>General

The General Menu contains the following submenus to make changes to various settings:

- Language
- ZONE2 Setup
- ZONE3 Setup
- Zone Rename
- Quick Select Names
- Trigger Out 1
- Trigger Out 2
- Auto Standby
- Front Display
- Firmware
- Information
- Save & Load
- Setup Lock

**Language** allows you to set the language for the display menus. The default is English, but the language can be changed to French or Spanish.

**Zone2 and Zone3 Setup** has the following options:

Menu Item	Zone Settings
Bass	-10dB to +10dB (Default 0dB)
Treble	-10dB to +10dB (Default 0dB)
High Pass Filter (HPF) attenuates low frequencies to reduce distortion	On / Off (Default)



Menu Item	Zone Settings
Lch Level (Left channel Output Level)	-12dB to +12dB (Default 0dB)
Rch Level (Right channel Output Level)	-12dB to +12dB (Default 0dB)
Channel	Stereo (Default) / Mono
HDMI Audio (Zone2 only)	Through (Default- HDMI audio signal passed to ZONE2 device) / PCM (HDMI is converted to PCM for ZONE2)
Volume Level	Variable / Fixed at a set volume of 1 to 98 (-79dB to 18dB)
Volume Limit (if Volume Level is Variable)	Off (no max) / 60 (-20dB) / 70 (-10dB) / 80 (0dB)-sets a maximum allowable volume
Power On Volume (if Volume Level is Variable)	Initial power on volume settings: Last (default) / Mute / 1 to 98 (-79dB to 18dB).
Mute Level	Full (default) / 40dB / -20dB

**Zone Rename** allows you to set custom names of up to 10 characters for each zone. Choosing the Set Defaults button will return to factory default names.

**Quick Select Names** allows you to set custom names for the four Quick Select buttons. This name will appear on the display. Choosing the Set Defaults button will return to factory default names.

**Trigger Out 1 and Trigger Out 2** menus allow you to set conditions for activating each Trigger Out. Inputs, Zones and monitors can be set to On to activate the respective Trigger Out. If the selection is set to ---, the Trigger Out will not be activated when that Zone, Input or HDMI monitor is chosen.

**Auto Standby** sets when each zone enters standby mode.

The MAIN ZONE can be set to go into standby mode after 15, 30, or 60 minutes of no audio or video signals. Setting Auto Standby to Off (which is the default) will prevent the MAIN ZONE from turning off.

ZONE2 and ZONE3 can be set to shut off after 2, 4 or 8 hours of no operation being performed. These zones will shut off automatically even if there is audio or video playing if no user input has been detected for the set time period.

**Front Display** provides options for the display brightness and whether the front panel signal display shows information for Input or Output. The current mode of the signal display is shown by either the IN or OUT Channel Indicators being lit.

Dimmer options are (in order of decreasing brightness):

- Bright (Default)
- Dim
- Dark
- Off (Display will turn off)

The Channel Indicator has two options:

- Input
- Output (default)

**Information** shows the status of the following:

- Audio- indicates current Sound Mode, Input Signal Type, Sample Rate, Channel Format, Offset (the dialogue normalization correction value)
- Video- shows HDMI Signal information (Resolution, Color Space and Pixel Depth); HDMI Monitor 1 (Interface and available resolutions); HDMI Monitor 2 (Interface and available resolutions)

- ZONE- has the option to display information for the MAIN ZONE (Select Source, Name, Sound Mode, Input Mode and Decode Mode, Type and Number of Connections -HDMI, Digital, Analog, Component Video and Composite Video, Video Mode, Content Type, Video Conversation, i/p Scaler) and for ZONE2/3 (Power, Select Source and Volume Level)

**Setup Lock** can be set to On to protect the MX123 from inadvertent changes. When Setup Lock is enabled, no other Setup options are displayed except for Setup Lock. To access other Setup items, set Setup Lock to Off (default).

## Save & Load

### Setup Menu>General>Save & Load

The Save & Load menu allows you to back up and restore configurations for the MX123. If you spent some time customizing your settings, it makes sense to create a backup. You will need a compatible USB memory device formatted to FAT32 with at least 128 MB of free space. Insert the USB memory device into the USB port labeled USB on the rear of the unit (see “USB” on page 9). Choose Save Configuration. Do not shut the power off until the operation is complete. A file named config.avi will be created. Do not change the name or it will not be recognized for restoring the configuration.

To restore the saved configuration, insert the USB memory device with the config.avi file and choose Load Configuration. Do not shut the power off during this process. When it is complete, “Loaded” will appear on the display and the MX123 will automatically restart.



## Firmware

### Setup Menu>General>Firmware

The MX123 A/V Processor can be setup to automatically download and install new firmware to make sure the unit has the latest updates. Updates can also be shutoff or manually performed. Options for this menu are:

**Check Update** will check for any available newer update. Use the BACK button on the Remote Control or the RETURN button to return to the previous menu.

**Auto-Update** can be turned On or Off. When On, new updates are downloaded and installed when the MX123 is in standby mode. The change Time Zone button allows you to set the proper time zone for where your unit resides.

**Allow Update** tells the MX123 whether updates are allowed. When set to Off all the other menu options for the Firmware menu will be greyed out. To have access to update options select On.

**Upgrade Notifications** can be set to On (default) or Off. When enabled, the MX123 will display an upgrade message upon powering on if a firmware upgrade is available. The notification will be displayed for about 40 seconds. If you do not wish to see these notifications, select Off for this option.

**Add New Feature** will check to see if new features are available and provide you with the option of upgrading if available.

### NEVER TURN OFF THE MX123 WHILE UPDATES ARE BEING INSTALLED.

If a message appears that an update or an upgrade failed, hold the red STANDBY ON button for more than 5 seconds or remove and re-insert the power cord. After about 1 minute, "Please wait" appears on the display and update restarts. If the error continues, please check the network environment.

## Description of Remote Control Buttons

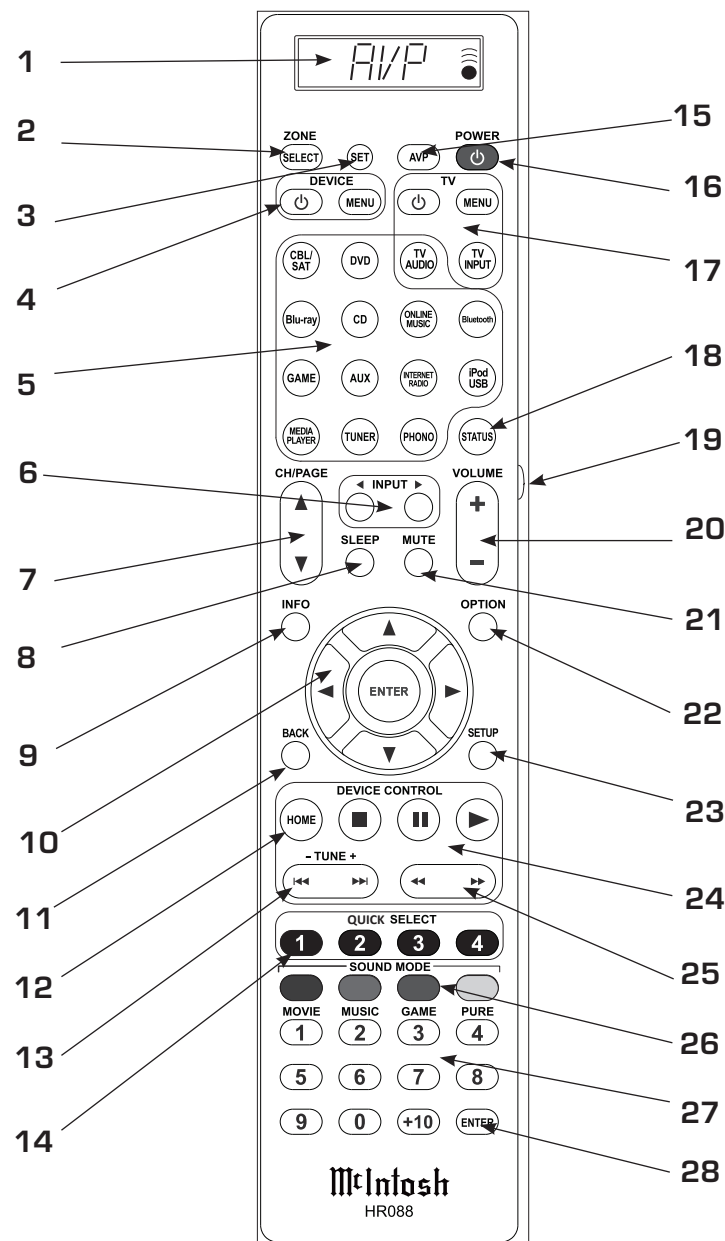

#	Name	Description
1	Display	Screen will display information. For most functions, "AVP" should be shown
2	SELECT	Pushing SELECT once will display the current Zone. Additional pushes will scroll through the available Zones. Stop on the Zone that you wish to control
3	SET	The SET button allows codes for other components to be entered. If you know a component's 4-digit code, enter it by pressing and holding the corresponding source button and then, also hold the SET button. Release when "PRESET" flashes. Enter the code when 4 dashes appear. "OK" will flash. The Display will show the source name. Manufacturers may have different codes for different models of the same type of product and not all codes are compatible with this remote
4	DEVICE	These buttons can be used to control Source components after Remote Control codes have been entered
5	SOURCES	Select from 14 available Audio Sources. (Note: the iPod/USB button will access the USB Input for the MX123. The iPod choice is for compatibility with older models.)
6	INPUT	Steps through available Inputs
7	CH/PAGE	Use to scroll through available Channels or Information pages
8	SLEEP	Sets Sleep timer from OFF to 120 minutes in 10 minute increments
9	INFO	Shows On-Screen information for the currently selected Input when in the Main Zone
10	Navigation	The four arrow buttons and center ENTER button allow for navigation and Input for various menus

#	Name	Description
11	BACK	Returns to previous SETUP menu
12	HOME	When the Source is Online Music or USB, the HOME button will bring up the Home Screen or Top Screen
13	TUNE	Selects Tuner presets and Disc tracks. Can be used as skip and search in Internet Radio
14	QUICK SELECT	Four buttons used to recall previously programmed presets such as Input, Volume Level and Sound Mode for the currently selected Zone
15	AVP	Pressing AVP will show "AVP" in the display which is needed for commands like SETUP and MENU
16	POWER	Press to power the MX123 ON and OFF
17	TV	These buttons will control a TV if the TV code was SET (#3)
18	STATUS	Displays the Status of the selected assignable Input
19	Light	Activates Display backlight
20	VOLUME	Adjusts Volume level up or down
21	MUTE	Mutes the audio or unmutes if muted
22	OPTION	Activates On-Screen Menu for Audio/Visual features
23	SETUP	Activates Setup mode. Press again to go back
24	DEVICE CONTROL	Controls transport Stop, Pause and Play functions
25	(SEEK)	Seeks selected Tuner station Up or Down
26	SOUND MODE	Offers various sound choices in Movie, Music, Game or Pure categories
27	Numbers	For number Input
28	ENTER	ENTER key for data Input



## Remote Control Batteries

The Remote Control, part number HR088, included with the MX123 is powered by two AAA batteries. To insert or remove batteries, open the battery compartment by removing the cover located on the back of the Remote Control. To open, pull the clasp located just above the opening downward.

## Audyssey®

Audyssey® is an intelligent system which will fine-tune your system to properly interact with the room's

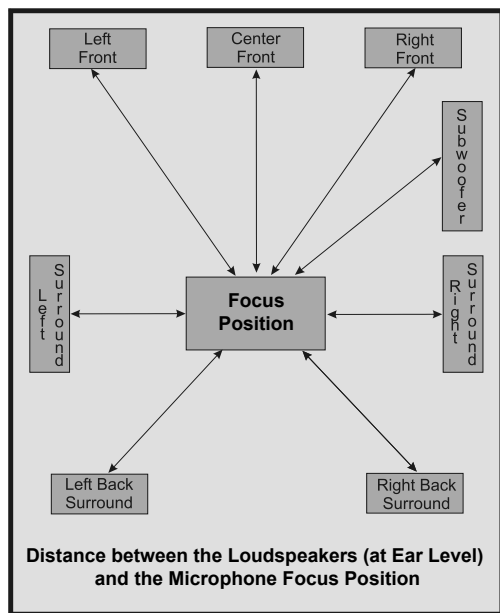

Figure 18– Audyssey® main listening position

acoustics through precise calibration. This will get the highest possible performance from your complete system providing a tighter and more detailed sound

with increased imaging.

Audyssey LFC™ solves the problem of low frequency sounds disturbing people in neighboring rooms or apartments. Audyssey LFC™ dynamically monitors the audio content and removes the low frequencies that pass through walls, floors and ceilings. It then applies psychoacoustic processing to restore the perception of low bass for listeners in the room. The result is great sound that no longer disturbs the neighbors.

The MX123 has two subwoofer Output capability and can adjust the level and delay for each subwoofer individually. Audyssey Sub EQ HT™ makes the integration seamless by first compensating for any level and delay differences between the two subwoofers and then applying Audyssey MultEQ® XT32 to both subwoofers together for improved deep bass response and detail.

Audyssey® Setup uses multiple measurement locations in the listening room to achieve the best possible acoustical results. The Focus Position or Main Listening Position is typically where one would be during serious viewing/listening.

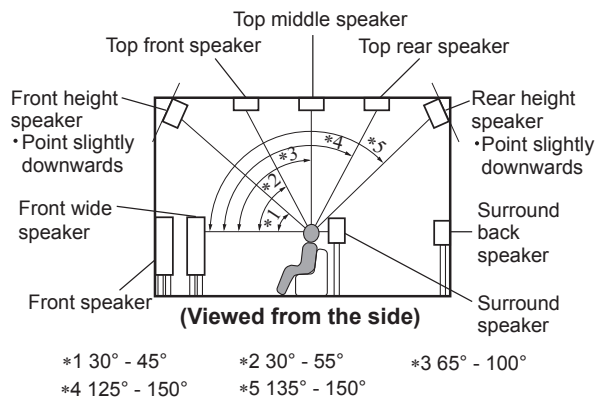

Figure 19– Speaker angles

Before proceeding with Audyssey® Auto Setup, it is very important to first go into the Setup Mode to establish the correct settings for your specific Loudspeaker complement and location in the Home Theater Room. This will not only assure the best acoustic performance using Audyssey® Room Equalization Correction, but it will also assure the best sonic performance using the latest in surround sound technology built into the MX123.

The acoustic characteristics of the connected speakers and listening room are measured and the optimum settings are made automatically.

## Audyssey® Setup

Assemble the supplied setup microphone and stand, then place it in the Main Listening Position or Focus Position. See Figure 18 on page 28.

For best results:

- Make the room as quiet as possible. Background noise can disrupt the room measurements. Close windows and turn off the power on electronic devices (radios, air conditioners, fluorescent lights, etc.). The measurements could be affected by the sounds emitted by such devices
- During the measurement process, place cell phones outside the listening room. Cell phone signals could disrupt the measurements
- Do not stand between the speakers and Sound calibration microphone or allow obstacles in the path while the measurements are being made. Also, install the Sound calibration microphone at least 20 inches (50cm) away from the wall. Failure to do so will result in inaccurate readings
- During the measurement process, audible test tones will come from the speakers and subwoofer(s), but this is part of normal

operation. If there is background noise in the room, these test signals will increase in volume

- Operating VOLUME on the Remote Control unit or VOLUME on the main unit during the measurements will cancel the measurements

With the MX123 connected to a TV/Monitor, the supplied microphone connected to the SETUP MIC Jack on the Rear Panel and placed in the "Main Listening Location", perform the following steps along with the instructions appearing On-Screen:

1. Press the AVP Push-button, then press the SETUP Push-button.
2. Using the Remote Control Directional Push-buttons first select "Speakers" followed by "Audyssey Setup". See Figure 20 below.

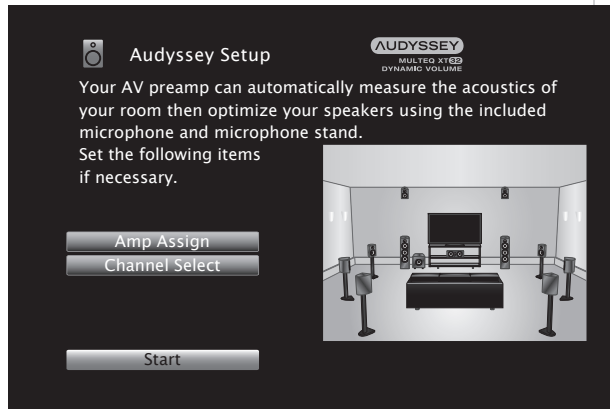

Figure 20– Audyssey® Setup Start

3. Select "Start", then press Enter.
4. Follow the instructions on the screen display and press "Next" to proceed further.
5. When the following screen is displayed, select "Begin Test" and press Enter. The first position measurement will start. See Figure 21.

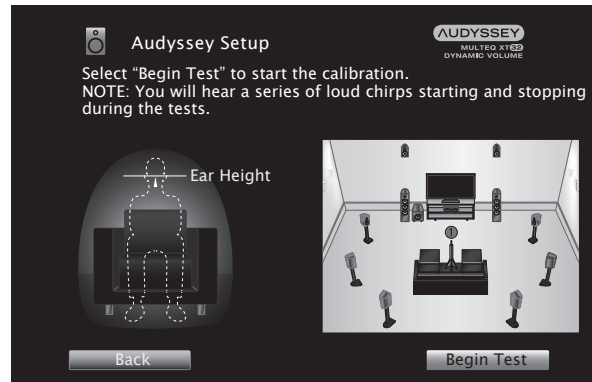

Figure 21– Audyssey® Begin Test

6. A test tone will be sent to all channels, one at a time to identify the channels making up your system.

Notes:

1. Depending on the number of channels in your system, the illustrations in this Owner's Manual might differ from the actual On-Screen Graphics.
2. During the setup process On-Screen error messages may appear, if they do, refer to page 31 for assistance.
7. When the detected speakers are displayed, select "Next" and then press Enter. This will start the Measurement Process. A special audio test signal will be sent to all previously detected channels, one at a time. See Figure 22.

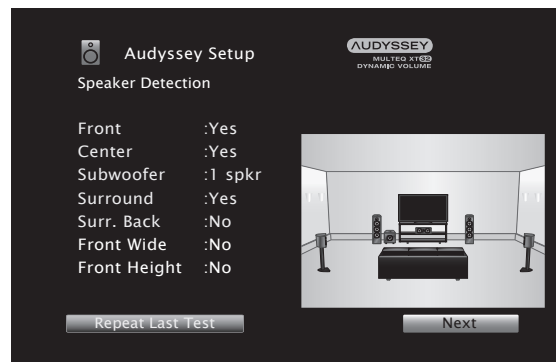

Figure 22– Speaker Detection

Audyssey® Setup will take measurements from eight different locations in the room to achieve the best possible sonic results. The additional measurement locations are indicated on your monitor by numbered blue balloons in the room illustration, placed around the sitting area and the Main sitting position. The Main sitting location is indicated by number "1".

8. Following the On-Screen instructions, place the microphone in the 2nd listening position and then press the ENTER Push-Button on the Remote Control to select highlighted on-screen button "Continue". See Figure 23.

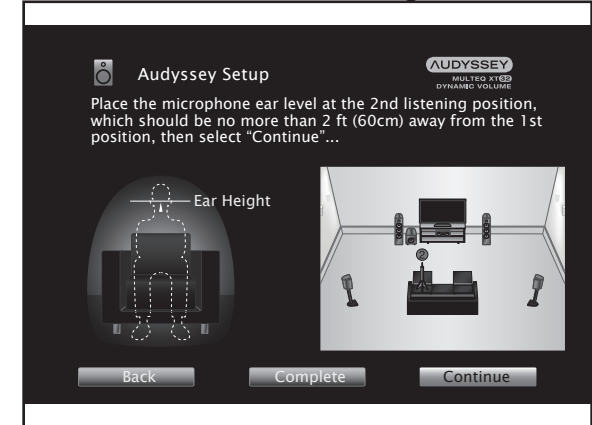

Figure 23– Microphone positioning

9. Continue following the On-Screen instructions and repeat the measurement process until all eight listening positions have been measured. The On-Screen message will now indicate the measurements are finished. See Figure 24 on page 30.

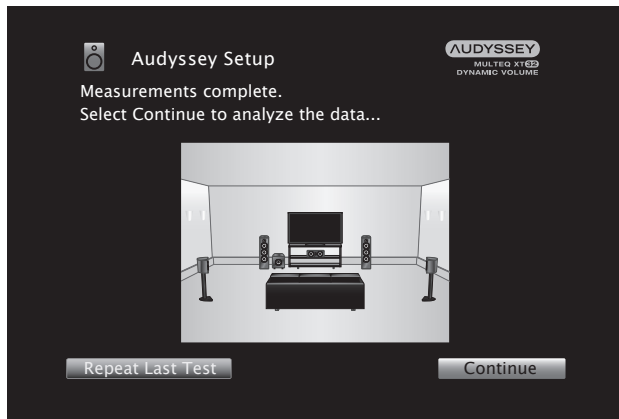

Figure 24– Measurements complete

Note: Measurement of 3 listening positions are required to enable MultEQ® XT32.

10. Select "Continue", then press Enter.
11. Perform the settings for Audyssey Dynamic EQ® and Audyssey Dynamic Volume®.

The following screen is displayed during the analysis. See Figure 25.

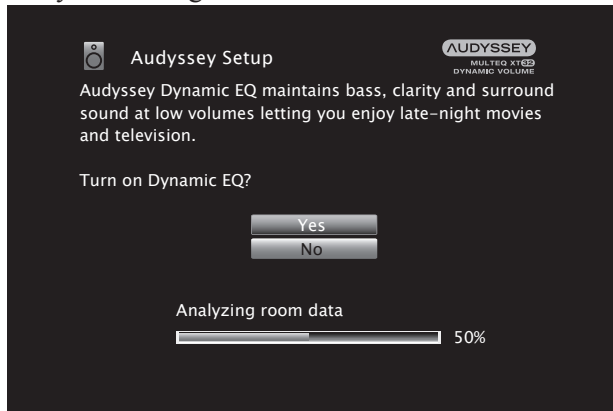

Figure 25– Dynamic EQ

Configure the settings as preferred.

- Dynamic EQ corrects the frequency response in consideration of the audio characteristics of the room and human hearing ability so that sound can

be heard even at low volume.

This is recommended when using the unit with the volume turned down, e.g. when enjoying a movie or TV program in the middle of the night.

- Dynamic Volume adjusts the Output volume to the optimal level while constantly monitoring the level of the audio Input to the unit. Optimal volume control is performed automatically without any loss in the dynamism and clarity of the sound when, for example, the volume suddenly increases for commercials shown during television programs.
12. When the analysis and storage ends, unplug the Sound Calibration Microphone from the SETUP MIC Jack on the Rear Panel and press Next.
  13. Select "Details" and press Enter to verify the measurement results.

- Subwoofers may measure a greater reported distance than the actual distance due to added electrical delay common in subwoofers.

Note: Do not change the speaker connections or subwoofer volume after Audyssey® Setup. If these are changed, run Audyssey® Setup again in order to configure the optimum equalizer settings.

## Error Messages

An error message is displayed if Audyssey® Setup could not be completed due to speaker placement, the measurement environment, etc. If an error message is displayed, check the relevant items and perform the necessary measures. Be sure to turn off the power before checking speaker connections.

### Subwoofer level error message and how to adjust

The optimal level of each subwoofer channel for Audyssey® Setup measurement is 75dB.

During subwoofer level measurement, an error message is displayed when one level of subwoofer

is outside the 72-78dB range. See Figure 26.

### Error message

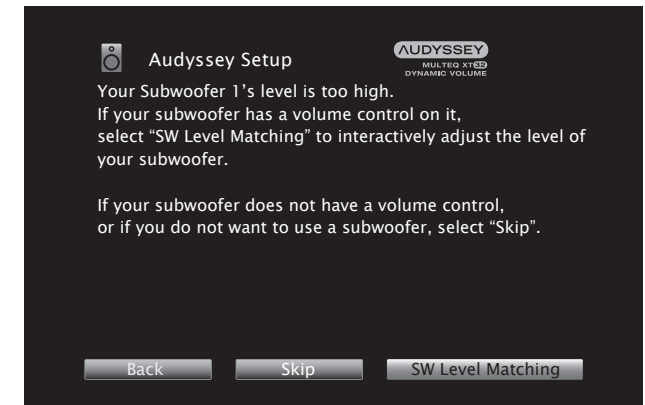

Figure 26– Audyssey® error message

When using a subwoofer with a built-in amplifier (active type), adjust the subwoofer volume so the subwoofer level is within the 72-78dB range.

### Retrieving Audyssey® Setup settings

If you set "Restore..." to "Restore", you can return to Audyssey® Setup measurement result (value calculated at the start by MultEQ® XT32) even when you have changed each setting manually. See Figure 27.

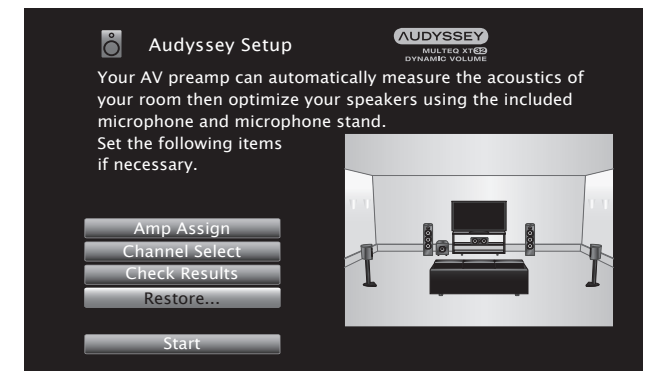

Figure 27– Audyssey® restore

An error message is displayed if Audyssey® Setup could not be completed due to speaker placement, the measurement environment, etc. If an error message is displayed, check the relevant items and perform the necessary measures. See Figure 28.

**Be sure to turn off the power before checking speaker connections.**

Examples	Error Details	Corrective Measures
No Speakers found	Sound calibration microphone is not detected  Not all speakers could be detected	Connect the included Sound Calibration Microphone to the SETUP MIC jack on the Rear Panel  Check the speaker connections
Ambient noise is too high or level is too low	There is too much noise in the room  Speaker or subwoofer sound is too low	Either turn off any device generating noise or move it away  Perform again when the surroundings are quieter  Check the speaker installation and the direction in which the speakers are facing  Adjust the subwoofer's volume
Front R: None	The displayed speaker could not be detected	Check the connections of the displayed speaker
Front R: Phase	The displayed speaker is connected with the polarities reversed	Check the polarity of the displayed speaker  For some speakers, this error message may be displayed even if the speaker is properly connected. If you are sure the connection is correct, press ► to select "Ignore", then press ENTER

Figure 28– Error table

## Factory Reset

Use the Factory Reset options to restore the MX123 back to its original factory defaults. These options will erase all changes made to the settings. The firmware will remain the latest installed version.

There are two portions to the Factory Reset. The first is the MCU (microcontroller unit) settings which includes all changes from the default settings. The second includes Network functions such as credentials for Online services. Each part can be reset individually or you can choose to reset both.

To perform a Factory Reset:

- Simultaneously, press and hold two buttons [A] and [B] while powering on the MX123 with the STANDBY/ON button
- Hold all three Buttons for at least 3 seconds while the power is on
- Release the buttons

Choose the two buttons, [A] and [B], according to what you want reset:

Button A	Button B	Function
MOVIE	MUSIC	Reset MCU only
RETURN	SLEEP	Reset MCU and Network module
RETURN	ENTER	Reset Network module only



## Bluetooth

The MX123 can pair with many Bluetooth devices. A maximum of 8 Bluetooth device pairings will be remembered. A ninth pairing will replace the oldest registered device. For Bluetooth Remote Control of the MX123 to function, the device must support the AVRCP profile. Supported functions are play, pause, stop, next, and previous. The connected device's volume will control the level of the signal sent to the MX123.

To pair a Bluetooth device with the MX123:

- Activate the Bluetooth setting on your mobile device
- Press and hold the Bluetooth button on the MX123 Remote Control for at least 3 seconds
- Select the MX123 from the list of discovered devices on your mobile Bluetooth device

## The Option Button

The Remote Control's OPTION button can be used in the MAIN Zone to adjust settings for the selected Input. Adjustments include:

- Dialog Enhancer- this function adjusts the center channel frequency band to enhance the dialog in the movies and vocals in music for easier listening
- Channel Level Adjust - each channel can be adjusted -12dB to +12dB while listening to music
- Tone- tone can be adjusted and stored for each channel. Tone can not be set if Sound Mode is set to Direct or Pure Direct or when Dynamic EQ is set to On
- Picture Mode- sets Picture Mode for

supported Inputs. For options see "Picture Adjust" on page 20

- All Zone Stereo- allows you to play music from the MAIN ZONE into ZONE2 and ZONE3. This will work for all Input modes except 7.1CH IN

## The Headphone Question

The All Zone Stereo option allows you to send analog stereo sound from a compatible HDMI signal to a unit such as a headphone amplifier connected to Zone2 or Zone3. This will allow you to listen via headphones given that you have headphones and an amplifier. You can mute the MAIN ZONE and continue to listen to stereo signals from units connected to the other Zones.

## Online Music

Choosing the Online Music Input provides three Input options for playing content:

- TuneIn Internet Radio
- Music Servers
- USB Music

**TuneIn Internet Radio** provides access to both local and international stations. Stations can be searched by music genre, location, station format or many other search criteria. There are over 120,000 stations (including McIntosh Music) so there is plenty of content that can be freely enjoyed.

Here are playable broadcast station specifications:

	Sampling frequency	Bit rate
WMA (.wma)	32/44.1/48 kHz	48-192 kbps
MP3 (.mp3)	32/44.1/48 kHz	32-320 kbps

	Sampling frequency	Bit rate
MPEG-4 AAC (.aac/.m4a/.mp4)	32/44.1/48 kHz	16-320 kbps

**Music Servers** gives you access to files stored on a DLNA compatible server on a PC or NAS connected to your network. Select the server you wish to access from the list under Music Servers. You can browse and search the files. The following formats can be played:

- WMA
- MP3
- WAV
- MPEG-4 AAC
- FLAC
- Apple Lossless
- DSD

Music can also be accessed from a **USB** memory device inserted into the USB port (labeled USB) in the rear of the MX123. The USB memory device must be formatted as either FAT16 or FAT32. The same file formats listed above for Music Servers are supported.

## Spotify Connect

Use your phone, tablet or computer as a remote control for Spotify. Go to [spotify.com/connect](http://spotify.com/connect) to learn how.

## Compatible Audio Formats

### From USB Memory Devices, PC and NAS

The MX123 can play 2-channel audio that is not copyright protected in the following audio formats:



Format	Sampling frequency	Bit rate
WMA (.wma)	32/44.1/48 kHz	48-192 kbps
MP3 (.mp3)	32/44.1/48 kHz	32-320 kbps
WAV (.wav)	32/44.1/48/88.2/ 96/176.4/192 kHz	NA
MPEG-4 AAC (.aac/.m4a/ mp4)	32/44.1/48 kHz	16-320 kbps
FLAC (.flac)	32/44.1/48/88.2/ 96/176.4/192 kHz	NA
Apple Lossless (m4a)	32/44.1/48/88.2/ 96/176.4/192 kHz	
DSD (.dsf/.dff)	2.8/5.6 MHz	NA

### From HDMI

The MX123 can play the following audio formats via HDMI:

2-channel Linear PCM	2-channel, 32 kHz – 192 kHz, 16/20/24 bit
Multi-channel Linear PCM	7.1-channel, 32 kHz – 192 kHz, 16/20/24 bit
Bitstream	Dolby Digital / DTS / Dolby Atmos / Dolby TrueHD / Dolby Digital Plus / DTS:X / DTS-HD Master Audio / DTS-HD High Resolution Audio / DTS Express
DSD	2-channel – 5.1-channel, 2.8 MHz

## Supported Video Signals

The MX123 supports the HDCP copyright protection system. For proper playback the connected video device must also support HDCP. Here are supported video signals:

- 480i
- 480p
- 576i
- 576p
- 720p 60/50Hz
- 1080i 60/50Hz
- 1080p 60/50/24Hz
- 4K 60/50/30/25/24Hz

## USB File and Folder Limits

The MX123 can support up to 5,000 files with a maximum of 500 folders and eight directory levels. Different USB memory devices may have different allowable number of files dependent of capacity and file size.

Memory capacity is 2GB with a FAT16 formatted device and 2TB with FAT32 formatting.

## About ARC and CEC

Note that the default setting for ARC (Audio Return Channel) is Off. To use ARC, it must be set to On. Turning HDMI Control On will also enable ARC. HDMI Control enables CEC (Consumer Electronics Control) commands to be transmitted over the HDMI cable so your television and MX123 can better communicate. ARC and HDMI Control (CEC) is factory defaulted to Off because the world of ARC and CEC is not yet perfect. It is certainly getting better, but not every component in the world is

speaking precisely the same language. These features can be enabled or disabled at any time on the MX123. See HDMI Setup on page 21. Remember to enable CEC on your television if you want to use CEC with the MX123.

HDMI Control (CEC) should also be set to Off, if you are using a third-party control system so that CEC does compete with your external controller.

The ARC feature, when enabled, will work with the TV Audio input and a television connected to the HDMI Monitor 1 (ARC) Output.



## Packing the MX123

When shipping the MX123, it is highly recommended that the unit be packed as it was originally shipped to avoid damage. Failure to properly pack the unit will likely result in damage. (The front panel is made of glass!) If you need any of the packing material, you can contact McIntosh Customer Service. Use only packing material that is in good condition and replace any material that has seen better days.

It is very important that the four plastic feet are attached to the bottom of the equipment. This will ensure the proper equipment location on the bottom pad. Failure to do this will result in shipping damage.

Quantity	Part Number	Description
1	034256	Shipping carton only
4	033887	End cap
2	034493	Spacer pad
1	033697	Inside carton only
1	033725	Inner carton top pad
1	034576	Bottom pad
2	034446	Foam plug
4	017937	Plastic foot
4	400159	#10-32 x 3/4" screw
4	404080	#10 Flat washer
1	034499	Accessory Box
2	034500	Slotted foam
1	034501	Divider foam

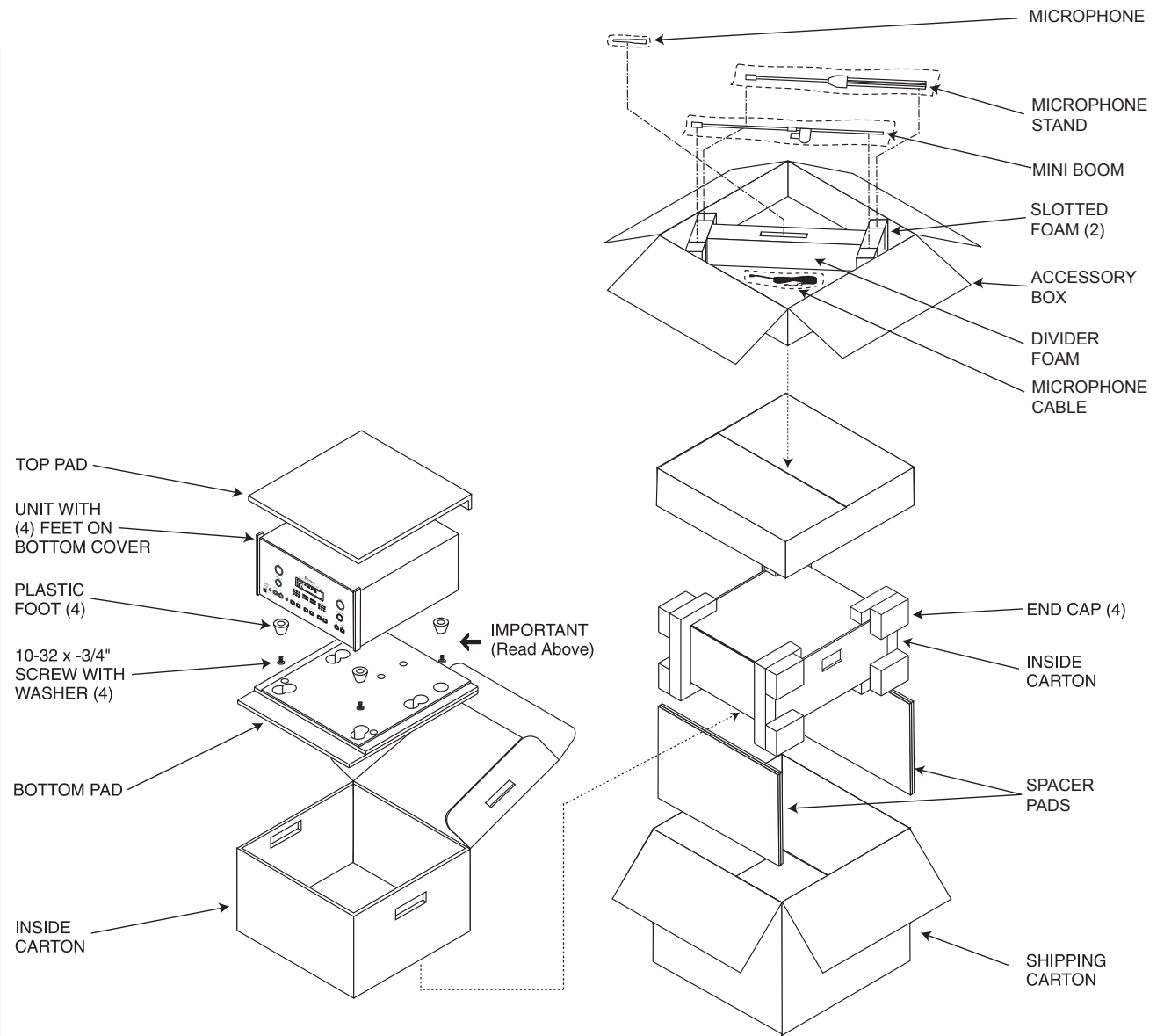

Figure 29– Re-packing diagram

---

## Audio Specifications

---

Unless otherwise noted, the below MX123 Specifications were taken with Audyssey® bypassed.

### Frequency Response

±0.5dB from 20Hz-20,000Hz

Subwoofer:

±0.5dB from 20Hz-8,000Hz

### Total Harmonic Distortion

0.005% maximum from 20Hz to 20,000Hz at rated Output

### Signal To Noise Ratio

Phono: 86dB below 10mV Input (A Weighted)

High Level: 96dB below rated Output (A Weighted)

### Rated Output Voltage

2.5V Unbalanced Outputs (Main)

5.0V Balanced Outputs (Main)

### Maximum Voltage Output

6V Unbalanced

12V Balanced

### Output Impedance

220 Ohms

### Input Impedance

Phono: 47k Ohms, 65pf

High Level: 20k Ohms Unbalanced and Balanced

### Sensitivity for Rated Output

Phono: 4.5mV

High Level: 450mV Unbalanced

900mV Balanced

### Maximum Input Signal

Phono: 50mV

High Level: 4.5V Unbalanced and Balanced

---

## Video Specifications

---

### Signal System

NTSC/PAL

### HDMI (Inputs and Outputs)

Version 2.0, High Dynamic Range (HDR), 4K Ultra HD@50/60Hz, 4:4:4 Color, Rec. 2020, 3D Video pass-through

### HDCP

Version 2.3

### Scaling

Analog and Digital Video Inputs scaled to a 4K Digital Signal

### Component Video Output Level

Y Output Level 1.0Vp-p (75 OHM)

PB/CB Output Level 0.7Vp-p (75 OHM)

PR/CR Output Level 0.7Vp-p (75 OHM)

### Composite Video Output Level

1Vp-p (75 OHM)

---

## General Specifications

---

### Power Requirements

*Field AC Voltage conversion of the MX123 is not possible. The MX123 is factory configured for one of the following AC Voltages:*

100 Volts, 50/60Hz at 75 watts

110 Volts, 50/60Hz at 75 watts

120 Volts, 50/60Hz at 75 watts

127 Volts, 50/60Hz at 75 watts

220 Volts, 50/60Hz at 75 watts

230 Volts, 50/60Hz at 75 watts

240 Volts, 50/60Hz at 75 watts

Standby, less than 0.5 watt

*Note: Refer to the rear panel of the MX123 for the correct voltage.*

### Overall Dimensions

Width is 17-1/2 inches (44.5cm)

Height is 7-5/8 inches (19.4cm) including feet

Depth is 19-1/2 inches (49.53cm) including the Front Panel, Knobs, Rear Panel Connections and USB Drive

### Weight

31 pounds (14Kg) net, 55 pounds (25Kg) in shipping carton

### Shipping Carton Dimensions

Width is 25 inches (63.5cm)

Depth is 28 inches (71.12cm)

Height is 18-3/8 inches (46.67cm)



The continuous improvement of its products is the policy of McIntosh Laboratory Incorporated who reserve the right to improve design without notice.

Printed in the U.S.A.

McIntosh Part No. 04199900